



## Overview of elements 2024

### Ordering correctly

#### Necessary Order Information

Complete and accurate data is absolutely necessary for the processing and production of your order, since an accurate and clear order allows us to immediately begin processing your order without time-consuming enquiries.

For this reason, your order must contain the following information:

- Range name and front number
- Handle number
- Drill pattern number
- Carcase colour number
- Plinth height and colour  
(if not specified, the standard plinth height of 150 mm will be supplied)
- Worktop design / décor
- Worktop edge design / edge colour
- Worktop sketch with dimensions and indication of tongue and groove joints
- Design of the worktop outer corner (for APD): square or round
- Upright / top shelf design including the colour number and upright thickness / Upright panel floor seal colour
- Shelf colours
- Glass design and / or colour
- Roll-up front colour
- Cornice profile / light pelmet profile including colour for each
- Order number and / or abbreviation
- Manufacturer information and built-in appliance model identification
- Kitchen block number (for kitchen block orders)
- Layout sketch with dimension information in 1:20 ratio
- Please draw / write any special productions in the centre of the layout sketch

### Dimensional drawings for upright panels

Uprights at end of run for base units, sideboards and tall units are supplied as standard with an upright panel shoe. The upright panel shoe is included in the price of the upright panel and is available in: 014 Stainless steel appearance, 010 Black. If no colour is specified in the order, the version 014 Stainless steel appearance will automatically be supplied.

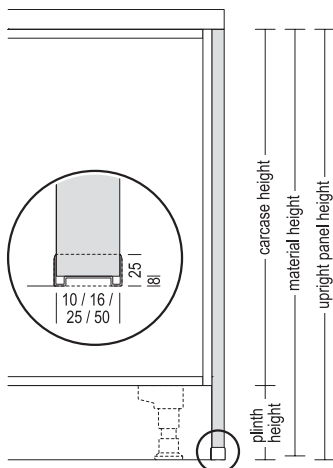

The height of the upright panel is reduced by the interior height dimensions of the profile and thus calculated as follows:

$$\begin{aligned} & \text{carcase height} \\ & + \text{plinth height} \\ & - 8 \text{ mm interior chamfering of the floor profile} \\ & = \text{material height} \end{aligned}$$

## Base units

Carcase depth: 561 mm  
 Carcase height: 720 mm  
 Plinth height: 70, 100, 150 or 200 mm

### Base units

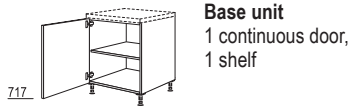

717  
**UD** 20/30/40/45/50/60 cm

**Base unit**  
 1 continuous door,  
 1 shelf

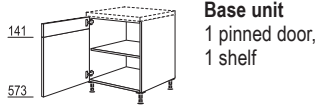

141  
 573  
**U** 20/30/40/45/50/60 cm

**Base unit**  
 1 pinned door,  
 1 shelf

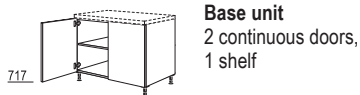

717  
**UD** 80/90/100/120 cm

**Base unit**  
 2 continuous doors,  
 1 shelf

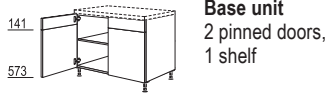

141  
 573  
**U** 80/90/100/120 cm

**Base unit**  
 2 pinned doors,  
 1 shelf

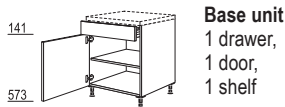

141  
 573  
**US** 30/40/45/50/60 cm

**Base unit**  
 1 drawer,  
 1 door,  
 1 shelf

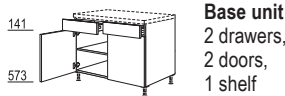

141  
 573  
**US** 80/90/100/120 cm

**Base unit**  
 2 drawers,  
 2 doors,  
 1 shelf



141  
 573  
**USG** 80/90/100/120 cm

**Base unit**  
 1 drawer,  
 2 doors,  
 1 shelf

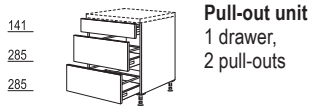

141  
 285  
 285  
**UA** 30/40/45/50/60/80/90/100/120 cm

**Pull-out unit**  
 1 drawer,  
 2 pull-outs

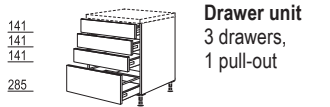

141  
 141  
 141  
 285  
**U3SA** 30/40/45/50/60/80/90/100/120 cm

**Drawer unit**  
 3 drawers,  
 1 pull-out

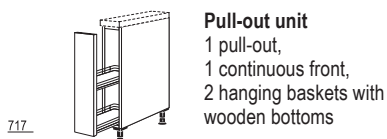

717  
**UAMD** 20/30 cm

**Pull-out unit**  
 1 pull-out,  
 1 continuous front,  
 2 hanging baskets with  
 wooden bottoms

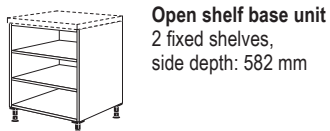

**UR** 15/20/30/40/45/50/60 cm

**Open shelf base unit**  
 2 fixed shelves,  
 side depth: 582 mm

### Corner base units

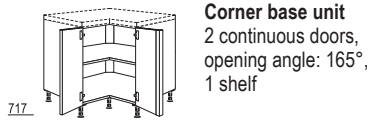

717  
**UDTE** 80/90 cm

**Corner base unit**  
 2 continuous doors,  
 opening angle: 165°,  
 1 shelf

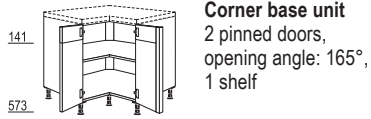

141  
 573  
**UTE** 80/90 cm

**Corner base unit**  
 2 pinned doors,  
 opening angle: 165°,  
 1 shelf

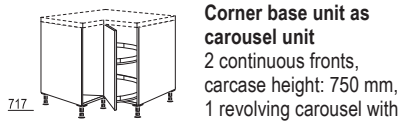

717  
**UEDK** 80/90 cm

**Corner base unit as  
 carousel unit**  
 2 continuous fronts,  
 carcase height: 750 mm,  
 1 revolving carousel with  
 2 wooden shelves and  
 metal railing, rotates 360°,  
 height adjustable top shelf

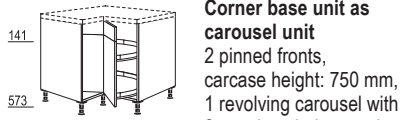

141  
 573  
**UEK** 80/90 cm

**Corner base unit as  
 carousel unit**  
 2 pinned fronts,  
 carcase height: 750 mm,  
 1 revolving carousel with  
 2 wooden shelves and  
 metal railing, rotates 360°,  
 height adjustable top shelf

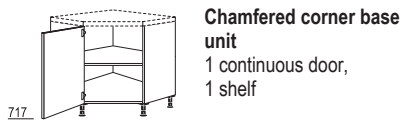

717  
**UED** 80/90 cm

**Chamfered corner base  
 unit**  
 1 continuous door,  
 1 shelf

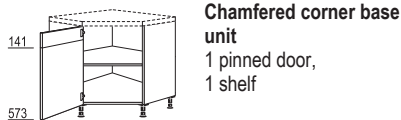

141  
 573  
**UE** 80/90 cm

**Chamfered corner base  
 unit**  
 1 pinned door,  
 1 shelf

### Half corner base units

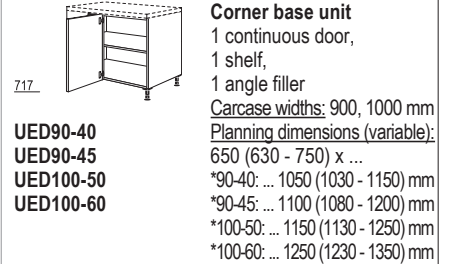

717  
**UED90-40**  
**UED90-45**  
**UED100-50**  
**UED100-60**

**Corner base unit**  
 1 continuous door,  
 1 shelf,  
 1 angle filler  
Carcase widths: 900, 1000 mm  
Planning dimensions (variable):  
 650 (630 - 750) x ...  
 \*90-40: ... 1050 (1030 - 1150) mm  
 \*90-45: ... 1100 (1080 - 1200) mm  
 \*100-50: ... 1150 (1130 - 1250) mm  
 \*100-60: ... 1250 (1230 - 1350) mm

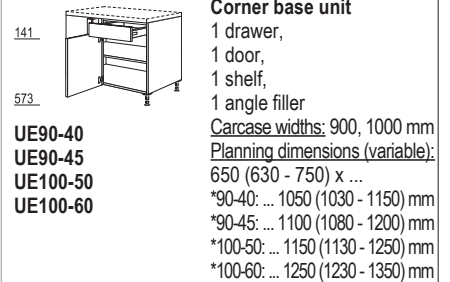

141  
 573  
**UE90-40**  
**UE90-45**  
**UE100-50**  
**UE100-60**

**Corner base unit**  
 1 drawer,  
 1 door,  
 1 shelf,  
 1 angle filler  
Carcase widths: 900, 1000 mm  
Planning dimensions (variable):  
 650 (630 - 750) x ...  
 \*90-40: ... 1050 (1030 - 1150) mm  
 \*90-45: ... 1100 (1080 - 1200) mm  
 \*100-50: ... 1150 (1130 - 1250) mm  
 \*100-60: ... 1250 (1230 - 1350) mm

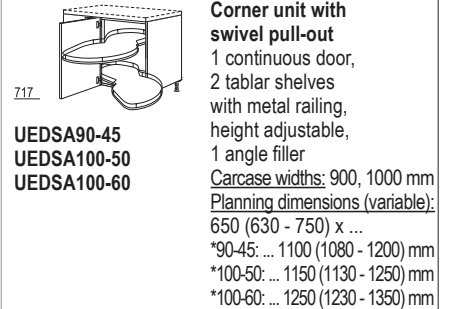

717  
**UEDSA90-45**  
**UEDSA100-50**  
**UEDSA100-60**

**Corner unit with  
 swivel pull-out**  
 1 continuous door,  
 2 tablar shelves  
 with metal railing,  
 height adjustable,  
 1 angle filler  
Carcase widths: 900, 1000 mm  
Planning dimensions (variable):  
 650 (630 - 750) x ...  
 \*90-45: ... 1100 (1080 - 1200) mm  
 \*100-50: ... 1150 (1130 - 1250) mm  
 \*100-60: ... 1250 (1230 - 1350) mm

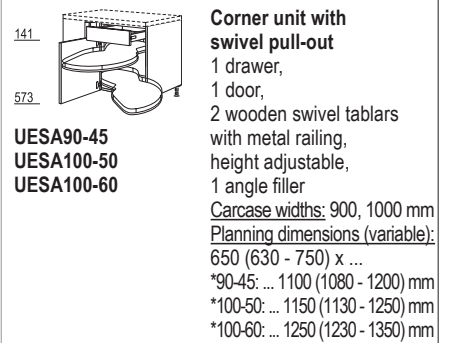

141  
 573  
**UESA90-45**  
**UESA100-50**  
**UESA100-60**

**Corner unit with  
 swivel pull-out**  
 1 drawer,  
 1 door,  
 2 wooden swivel tablars  
 with metal railing,  
 height adjustable,  
 1 angle filler  
Carcase widths: 900, 1000 mm  
Planning dimensions (variable):  
 650 (630 - 750) x ...  
 \*90-45: ... 1100 (1080 - 1200) mm  
 \*100-50: ... 1150 (1130 - 1250) mm  
 \*100-60: ... 1250 (1230 - 1350) mm

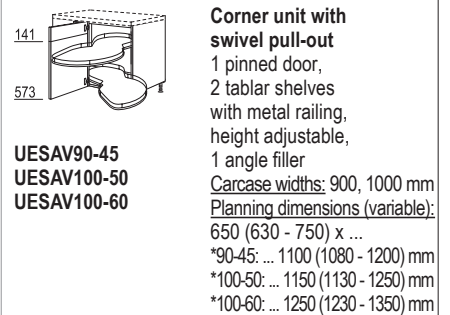

141  
 573  
**UESAV90-45**  
**UESAV100-50**  
**UESAV100-60**

**Corner unit with  
 swivel pull-out**  
 1 pinned door,  
 2 tablar shelves  
 with metal railing,  
 height adjustable,  
 1 angle filler  
Carcase widths: 900, 1000 mm  
Planning dimensions (variable):  
 650 (630 - 750) x ...  
 \*90-45: ... 1100 (1080 - 1200) mm  
 \*100-50: ... 1150 (1130 - 1250) mm  
 \*100-60: ... 1250 (1230 - 1350) mm

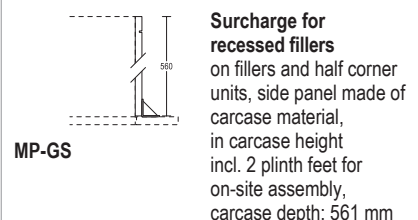

**MP-GS**

**Surcharge for  
 recessed fillers**  
 on fillers and half corner  
 units, side panel made of  
 carcase material,  
 in carcase height  
 incl. 2 plinth feet for  
 on-site assembly,  
 carcase depth: 561 mm

## Base units

Carcase depth: 561 mm  
 Carcase height: 720 mm  
 Plinth height: 70, 100, 150 oder 200 mm

### Angle fillers

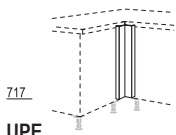

UPE  
UPE-V

**Angle filler**  
 Continuous front material,  
 70 x 70 mm, planning  
 dimensions: 650 x 650 mm

as above, however **variable**  
 from 50 to 170 mm, planning  
 dimensions: 630 - 750 mm  
 1st dimension = left /  
 2nd dimension = right

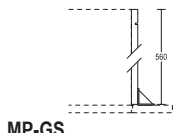

MP-GS

**Surcharge for  
 recessed fillers**  
 on fillers and half corner  
 units, side panel made of  
 carcase material,  
 in carcase height  
 incl. 2 plinth feet for  
 on-site assembly,  
 carcase depth: 561 mm

### Fillers / Panelling

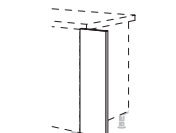

UPK 10/20 cm

**Filler**  
 Carcase material,  
 720 mm high,  
 U-shaped seal for  
 connection to wall,  
 width: 100 / 200 mm

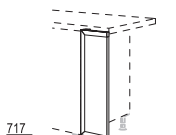

UPD 20 cm

**Front filler**  
 Continuous front material,  
 width: 200 mm

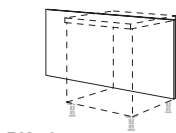

RK-72

**Base unit back panel**  
 16 mm thick,  
 720 mm high,  
 width: 250 - 2000 mm,  
 available in all carcase and  
 worktop décors from décor  
 group 1,  
 Vario clip fastening,  
 in case of reproduction  
 finishes vertical wood grain

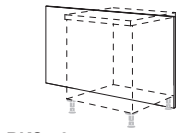

RKS-72

as above, however,  
 continuous height,  
 including floor profile:  
 70 mm plinth height:  
 810 mm  
 100 mm plinth height:  
 840 mm  
 150 mm plinth height:  
 890 mm  
 200 mm plinth height:  
 940 mm

**Available floor profile  
 colours:**  
 010 Black  
 014 Stainless steel  
 appearance

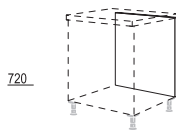

RFD-72

30/40/45/50/60/80/90 cm

### Cooker housing

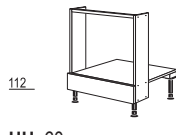

HU 60 cm

**Cooker housing**  
 1 fixed panel,  
 side sections: 202 mm deep,  
 aperture dimension: 591 mm

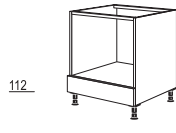

HUB 60 cm

**Cooker housing**  
 1 fixed panel,  
 aperture dimension: 598 mm

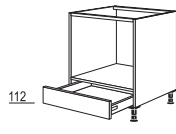

HUS 60 cm

**Cooker housing**  
 1 plastic drawer,  
 16 l capacity,  
 interior dimensions:  
 485 x 480 x 68 mm,  
 aperture dimension: 598 mm

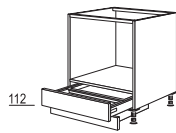

HUG 60 cm

**Cooker housing**  
 1 large-capacity drawer with  
 second level for baking trays,  
 plastic, 30 l capacity,  
 interior dimensions:  
 480 x 380 x 150 mm,  
 aperture dimension: 598 mm

### Hot plate units



KD60 60 cm

**Hot plate unit**  
 1 internal panel,  
 1 construction shelf for  
 heat insulation,  
 1 door,  
 1 shelf

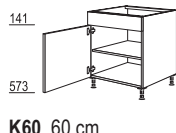

K60 60 cm

**Hot plate unit**  
 1 fixed panel,  
 1 construction shelf for  
 heat insulation,  
 1 door,  
 1 shelf



KS60 60 cm

**Hot plate unit**  
 1 drawer,  
 1 spacer shelf for hot plate,  
 1 door,  
 1 shelf

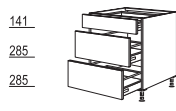

KS2A  
 60/80/90/100/120 cm

**Hot plate unit**  
 1 drawer,  
 1 spacer shelf for hot plate,  
 2 pull-outs



KD2A  
 60/80/90/100/120 cm

**Hot plate unit**  
 1 internal panel,  
 1 construction shelf for heat  
 insulation,  
 2 pull-outs

### Sink units

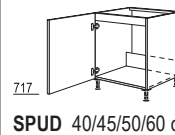

SPUD 40/45/50/60 cm

**Sink base unit**  
 1 internal panel,  
 1 continuous door

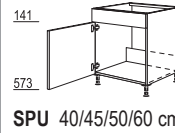

SPU 40/45/50/60 cm

**Sink base unit**  
 1 fixed panel,  
 1 door

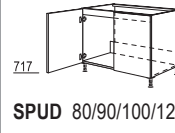

SPUD 80/90/100/120 cm

**Sink base unit**  
 2 internal panels,  
 2 continuous doors

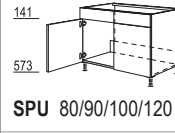

SPU 80/90/100/120 cm

**Sink base unit**  
 2 fixed panels,  
 2 doors



SPUAD  
 40/45/50/60 cm

**Sink base unit**  
 1 internal panel,  
 1 continuous front with  
 centred handle,  
 without pull-out rails and  
 drill holes

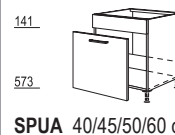

SPUA 40/45/50/60 cm

**Sink base unit**  
 1 fixed panel,  
 1 front with centred handle,  
 without pull-out rails and  
 drill holes



SPUDA-ASK  
 45/50/60 cm

**Sink base unit  
 Separato-K**  
 1 internal panel,  
 1 pull-out, 500 mm deep, with  
 waste separation system  
**Separato-K**  
 with pull-out lid,  
 1 x 18 and 2 x 8 litres,  
 500 mm width: with  
 1 side organiser,  
 600 mm width: with  
 2 side organisers,  
 1 bio lid (for all widths)

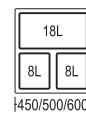

1450/500/600

### Doors for integrated appliances

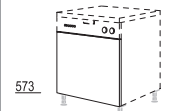

GSB 45/60 cm

**Door**  
 for integrated  
 dishwashers,  
 without handle

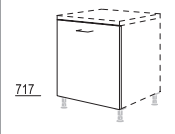

GSBD\*-I 45/60 cm

**Continuous door**  
 for fully integrated  
 dishwashers,  
 built-under fridge and  
 freezer units  
 with pull-outs

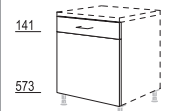

GSB\*-I 45/60 cm



**Pinned door**  
 for fully integrated  
 dishwashers,  
 built-under fridge and  
 freezer units  
 with pull-outs

## Base units in XL height



Carcase depth: 561 mm  
 Carcase height: 792 mm  
 Plinth height: 70, 100, 150 or 200 mm

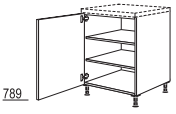

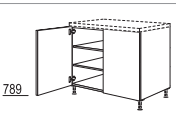
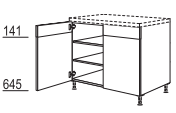
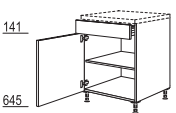
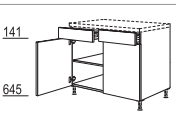
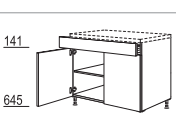
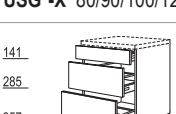
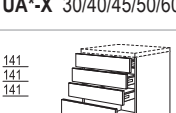
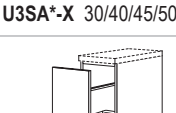
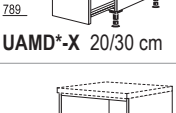

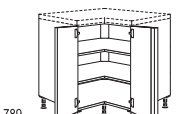
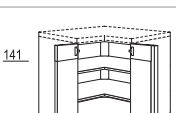
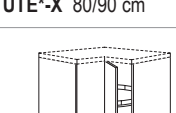
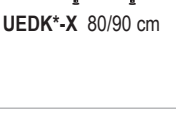

### XL Base units

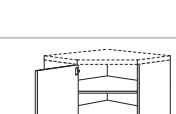
	<b>XL Base unit</b> 1 continuous door, 2 shelves
789	<b>UD*-X</b> 20/30/40/45/50/60 cm
	<b>XL Base unit</b> 1 pinned door, 2 shelves
141 645	<b>U*-X</b> 20/30/40/45/50/60 cm
	<b>XL Base unit</b> 2 continuous doors, 2 shelves
789	<b>UD*-X</b> 80/90/100/120 cm
	<b>XL Base unit</b> 2 pinned doors, 2 shelves
141 645	<b>U*-X</b> 80/90/100/120 cm
	<b>XL Base unit</b> 1 drawer, 1 door, 1 shelf
141 645	<b>US*-X</b> 30/40/45/50/60 cm
	<b>XL Base unit</b> 2 drawers, 2 doors, 1 shelf
141 645	<b>US*-X</b> 80/90/100/120 cm
	<b>XL Base unit</b> 1 drawer, 2 doors, 1 shelf
141 645	<b>USG*-X</b> 80/90/100/120 cm
	<b>XL Pull-out unit</b> 1 drawer, 2 pull-outs
141 285 357	<b>UA*-X</b> 30/40/45/50/60/80/90/100/120 cm
	<b>XL Drawer unit</b> 3 drawers, 1 pull-out
141 141 357	<b>U3SA*-X</b> 30/40/45/50/60/80/90/100/120 cm
	<b>XL Pull-out unit</b> 1 pull-out, 1 continuous front, 2 hanging baskets with wooden bottoms
789	<b>UAMD*-X</b> 20/30 cm
	<b>XL Open shelf base unit</b> 2 fixed shelves, side depth: 582 mm
	<b>UR*-X</b> 15/20/30/40/45/50/60 cm

### XL Corner base units

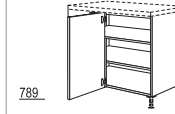
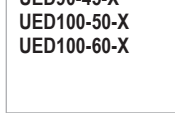
	<b>XL Corner base unit</b> 2 continuous doors, opening angle: 165°, 2 shelves
789	<b>UDTE*-X</b> 80/90 cm
	<b>XL Corner base unit</b> 2 pinned doors, opening angle: 165°, 2 shelves
141 645	<b>UTE*-X</b> 80/90 cm
	<b>XL Corner base unit as carousel unit</b> 2 continuous fronts, Unit height: 822 mm, 1 revolving carousel with 2 wooden shelves and metal railing, rotates 360° height adjustable top shelf
789	<b>UEDK*-X</b> 80/90 cm
	<b>XL Corner base unit as carousel unit</b> 2 pinned fronts, Unit height: 822 mm, 1 revolving carousel with 2 wooden shelves and metal railing, rotates 360° height adjustable top shelf
141 645	<b>UEK*-X</b> 80/90 cm
	<b>XL Chamfered corner base unit</b> 1 continuous door, 2 shelves
789	<b>UED*-X</b> 80/90 cm
	<b>XL Chamfered corner base unit</b> 1 pinned door, 2 shelves
141 645	<b>UE*-X</b> 80/90 cm

### XL Half-corner units

	<b>XL Corner base unit</b> 1 continuous door, 2 shelves, 1 angle filler Carcase widths: 900, 1000 mm Planning dimensions (variable): 650 (630 - 750) x ... *90-40: ... 1050 (1030 - 1150) mm *90-45: ... 1100 (1080 - 1200) mm *100-50: ... 1150 (1130 - 1250) mm *100-60: ... 1250 (1230 - 1350) mm
789	<b>UED90-40-X</b> <b>UED90-45-X</b> <b>UED100-50-X</b> <b>UED100-60-X</b>
	<b>XL Corner base unit</b> 1 drawer, 1 door, 1 shelf, 1 angle filler Carcase widths: 900, 1000 mm Planning dimensions (variable): 650 (630 - 750) x ... *90-40: ... 1050 (1030 - 1150) mm *90-45: ... 1100 (1080 - 1200) mm *100-50: ... 1150 (1130 - 1250) mm *100-60: ... 1250 (1230 - 1350) mm
141 645	<b>UE90-40-X</b> <b>UE90-45-X</b> <b>UE100-50-X</b> <b>UE100-60-X</b>
	<b>XL Corner unit with swivel pull-out</b> 1 continuous door, 2 wooden swivel tablers with metal railing, height adjustable, 1 angle filler Carcase widths: 900, 1000 mm Planning dimensions (variable): 650 (630 - 750) x ... *90-45: ... 1100 (1080 - 1200) mm *100-50: ... 1150 (1130 - 1250) mm *100-60: ... 1250 (1230 - 1350) mm
789	<b>UEDSA90-45-X</b> <b>UEDSA100-50-X</b> <b>UEDSA100-60-X</b>
	<b>XL Corner unit with swivel pull-out</b> 1 drawer, 1 door, 2 wooden swivel tablers with metal railing, height adjustable, 1 angle filler Carcase widths: 900, 1000 mm Planning dimensions (variable): 650 (630 - 750) x ... *90-45: ... 1100 (1080 - 1200) mm *100-50: ... 1150 (1130 - 1250) mm *100-60: ... 1250 (1230 - 1350) mm
141 645	<b>UESA90-45-X</b> <b>UESA100-50-X</b> <b>UESA100-60-X</b>
	<b>XL Corner unit with swivel pull-out</b> 1 pinned door, 2 wooden swivel tablers with metal railing, height adjustable, 1 angle filler Carcase widths: 900, 1000 mm Planning dimensions (variable): 650 (630 - 750) x ... *90-45: ... 1100 (1080 - 1200) mm *100-50: ... 1150 (1130 - 1250) mm *100-60: ... 1250 (1230 - 1350) mm
141 645	<b>UESAV90-45-X</b> <b>UESAV100-50-X</b> <b>UESAV100-60-X</b>
	<b>Surcharge for recessed fillers</b> on fillers and half corner units, side panel made of carcase material, in carcase height incl. 2 plinth feet for on-site assembly, carcase depth: 561 mm
	<b>MP-GS</b>

## Base units in XL height

Carcase depth: 561 mm  
 Carcase height: 792 mm  
 Plinth height: 70, 100, 150 or 200 mm



### XL Angle fillers

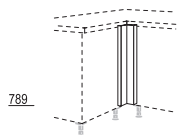

**XL Angle filler**  
 Continuous front material,  
 70 x 70 mm, Planning  
 dimensions: 650 x 650 mm

UPE-X  
 UPE-V-X

as above, however **variable**  
 from 50 to 170 mm, Planning  
 dimensions: 630 - 750 mm  
 1st dimension = left  
 2nd dimension = right

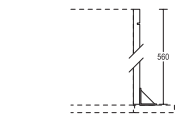

MP-GS

**Surcharge for recessed fillers**  
 on fillers and half corner  
 units, side panel made of  
 carcase material,  
 in carcase height  
 incl. 2 plinth feet for  
 on-site assembly,  
 carcase depth: 561 mm

### XL Fillers / Panelling

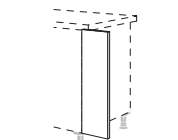

UPK\*-X 10/20 cm

**XL Filler**  
 Carcase material,  
 792 mm high,  
 U-shaped seal for  
 connection to wall,  
 width: 100 / 200 mm



UPD\*-X 20 cm

**XL Front filler**  
 Continuous front material,  
 width: 200 mm

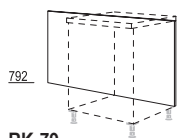

RK-79

**XL Base unit back panel**  
 16 mm thick,  
 792 mm high,  
 width: 250 - 2000 mm,  
 available in all carcase and  
 worktop décors from décor  
 group 1,  
 Vario clip fastening,  
 in case of reproduction  
 finishes vertical wood grain

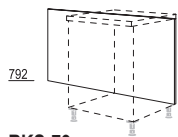

RKS-79

as above, however,  
 continuous height,  
 including floor profile:  
 70 mm plinth height:  
 882 mm  
 100 mm plinth height:  
 912 mm  
 150 mm plinth height:  
 962 mm  
 200 mm plinth height:  
 1012 mm

**Available floor profile colours:**  
 010 Black  
 014 Stainless steel  
 appearance

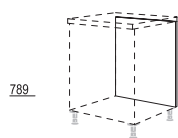

RFD\*-79  
 30/40/45/50/60 cm

**XL Base unit back panel**  
 1 continuous front,  
 789 mm high,  
 Vario clip fastening,  
 without drill holes

### XL Cooker housings



HUB-X 60 cm

**XL Cooker housing**  
 1 fixed panel,  
 aperture dimension: 595 mm

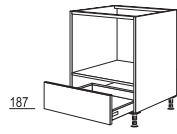

HUS\*-X 60 cm

**XL Cooker housing**  
 1 plastic drawer,  
 16 l capacity,  
 interior dimensions:  
 485 x 480 x 68 mm  
 aperture dimension: 595 mm

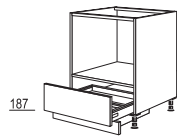

HUG-X 60 cm

**XL Cooker housing**  
 1 large-capacity drawer  
 with second level for baking  
 trays, plastic, 30 l capacity,  
 interior dimensions:  
 480 x 380 x 150 mm,  
 aperture dimension: 595 mm

### XL Hot plate units



KD60-X 60 cm

**XL Hot plate unit**  
 1 internal panel,  
 1 construction shelf for heat  
 insulation,  
 1 door,  
 2 shelves

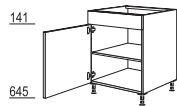

K60-X 60 cm

**XL Hot plate unit**  
 1 fixed panel,  
 1 construction shelf for heat  
 insulation,  
 1 door,  
 1 shelf

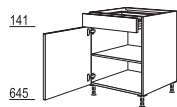

KS60-X 60 cm

**XL Hot plate unit**  
 1 drawer,  
 1 spacer shelf for hot plate,  
 1 door,  
 1 shelf



KS2A\*-X  
 60/80/90/100/120 cm

**XL Hot plate unit**  
 1 drawer,  
 1 spacer shelf for hot plate,  
 2 pull-outs

### XL-Doors for integrated appliances

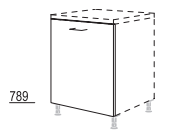

GSBD\*-I-X 45/60 cm

**Continuous XL door**  
 for fully integrated  
 dishwashers,  
 built-under fridge and  
 freezer units  
 with pull-outs,  
 includes spacer strip

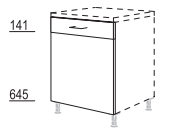

GSB\*-I-X 45/60 cm

**Pinned XL door**  
 for fully integrated  
 dishwashers,  
 built-under fridge and  
 freezer units  
 with pull-outs,  
 includes spacer strip

### XL Sink base units

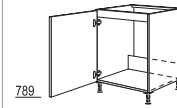

SPUD\*-X 40/45/50/60 cm

**XL Sink base unit**  
 1 internal panel,  
 1 continuous door

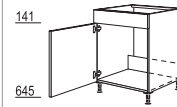

SPU\*-X 40/45/50/60 cm

**XL Sink base unit**  
 1 fixed panel,  
 1 door

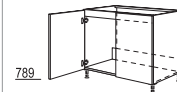

SPUD\*-X 80/90/100/120 cm

**XL Sink base unit**  
 2 internal panels,  
 2 continuous doors

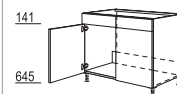

SPU\*-X 80/90/100/120 cm

**XL Sink base unit**  
 2 fixed panels,  
 2 doors

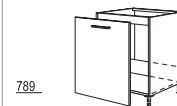

SPUAD\*-X  
 40/45/50/60 cm

**XL Sink base unit**  
 1 internal panel,  
 1 continuous front with  
 centred handle,  
 without pull-out rails and  
 drill holes

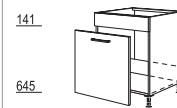

SPUA\*-X 40/45/50/60 cm

**XL Sink base unit**  
 1 fixed panel,  
 1 front with centred handle,  
 without pull-out rails and  
 drill holes

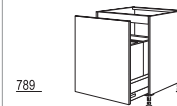

SPUDA-ASK\*-X  
 45/50/60 cm

**XL Sink unit Separato-K**  
 1 internal panel,  
 1 pull-out, 500 mm deep, with  
**waste separation system**  
**Separato-K**  
 with pull-out lid,  
 1 x 18 and 2 x 8 litres,  
 500 mm width: with  
 1 side organiser,  
 600 mm width: with  
 2 side organisers,  
 1 bio lid (for all widths)

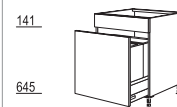
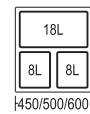

SPUA-ASK\*-X  
 45/50/60 cm

**XL Sink unit Separato-K**  
 1 fixed panel,  
 1 pull-out, 500 mm deep, with  
**waste separation system**  
**Separato-K**  
 with pull-out lid,  
 1 x 18 and 2 x 8 litres,  
 500 mm width: with  
 1 side organiser,  
 600 mm width: with  
 2 side organisers,  
 1 bio lid (for all widths)

## Worktops | Niche cladding

### Worktops

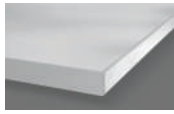

**APN**  
60/70/80/90/100/  
110/120 cm

**Worktop APN with N-edge**  
rounded front edge, sides sealed with straight décor edge.  
Price per running 100 mm, every 100 mm started will be invoiced.  
**Max. length:**  
Décor group 1: 5100 mm,  
Décor group 2  
(Xtra décors): 4000 mm  
Please quote the décor number in your order.

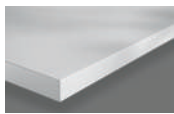

**APD**  
60/70/80/90/100/  
110/117 cm

**Worktop APD with décor edge**  
front and side edges coated with straight décor edging material, 1.5 mm thick.  
Price per running 100 mm, every 100 mm started will be invoiced.  
**Max. length:**  
Décor group 1: 5100 mm,  
Décor group 2  
(Xtra décors): 4000 mm  
Please quote the décor and edge colour number in your order.

### Worktop processing

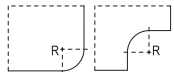

**AP-R**

**Surcharge for exterior and interior roundings deviating from the standard radii**

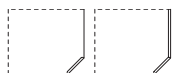

**APN-A**  
**APN-AS**  
**APD-A**

**Surcharge for chamfered cuts**  
on worktops and tables, including edging

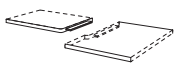

**AP-NF**

**Tongue and groove joint**  
for worktop corners or extensions, incl. screw fittings, tongues and water resistant glue

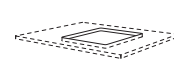

**AP-AUS**

**Cut-outs for built in hobs, sinks or ventilation grills**



**AP-IEK**

**Surcharge for inner corners in square design**  
on worktops and tables with décor edge

### Niche cladding



**NV 54**  
**NV 70**

**Niche cladding**  
coated on both faces, 16 mm thick, **horizontal structure (except 226 Metal art décor and 274 Teramo marble reproduction)**  
with edge on all sides, width: 250 - 2580 mm **heights:**  
NV54 for niches beneath wall units  
NV70 for niches beneath cooker hoods

**Price per started 100 mm.**

**NV 203**

Niche cladding as above, **however with deviating dimensions acc. to sketch**  
max. 2580 mm wide, 2030 mm high, **1st dimension in direction of grain**  
coated edge all round.  
Minimum price: 0.5 m<sup>2</sup>, minimum dimensions: 250 x 200 mm, **invoiced per m<sup>2</sup>.**

### Accessories for niche cladding



**NPUK 500**

**Plastic cover profile in translucent appearance**  
for niche or back panel cladding, 16 mm thick, self-adhesive, 5000 mm long



**WAPN**  
200/400/500 cm

**Upstands for continuous planning with niche cladding**  
2-piece plastic profile with sealing lip, incl. vertical sealing profile dimensions: 25 mm high, 25 mm deep, **delivered as strand material.**

**Available in:**  
014 Stainless steel appearance, 010 Black



**WAPN-Z**

**WAPN accessory bag**  
matches the plastic upstands WAPN consisting of:  
4 x interior corner 90° /  
2 x interior corner 135°  
2 x exterior corner 90°  
2 x set of end caps for WAPN  
2 x set of end caps for niche cladding

**Available in:**  
014 Stainless steel appearance, 010 Black



**NKPU 200 / 400**

**Niche profile on bottom**  
**Aluminium profile, 2-piece with sealing profile**  
for niche and back panel cladding or as upstand, dimensions: 17 mm high, 20 mm deep

**Available in:**  
014 Stainless steel appearance, 010 Black



**NKPO 200 / 400**

**Niche profile on top aluminium profile, stainless steel appearance**  
for niche cladding incl. 1 set of end caps (left / right), dimensions: 16 mm high, 16 mm deep



**NKP-Z**

**NKP accessory bag**  
matches upstand NKPU  
**Available in:**  
014 Stainless steel appearance, 010 Black



**NKP-EK**

**1 set of end caps**  
matching aluminium profile for niche cladding NKPO

# Upright panels | Top shelves | Wall shelf units

## Upright panels for base units

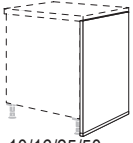

**Upright at end of run**  
incl. floor profile in  
014 Stainless steel  
appearance or  
010 Black,  
depth: 583 mm

**UWA** 10/16/25/50 mm

Plinth height 70 mm: 790 mm  
Plinth height 100 mm: 820 mm  
Plinth height 150 mm: 870 mm  
Plinth height 200 mm: 920 mm

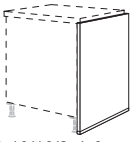

**Upright for room designs**  
depth: 250 to 1166 mm,  
edged on both sides,  
incl. floor profile in  
014 Stainless steel  
appearance or  
010 Black

**UWR** 10/16/25/50 mm

Plinth height 70 mm: 790 mm  
Plinth height 100 mm: 820 mm  
Plinth height 150 mm: 870 mm  
Plinth height 200 mm: 920 mm

## XL Upright panels for base units

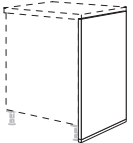

**XL Upright at end of run**  
incl. floor seal in  
014 Stainless steel  
appearance or  
010 Black,  
depth: 583 mm

**UWA\*-X** 10/16/25/50 mm

Plinth height 70 mm: 862 mm  
Plinth height 100 mm: 892 mm  
Plinth height 150 mm: 942 mm  
Plinth height 200 mm: 992 mm

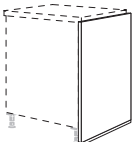

**XL Upright for room designs**  
depth: 250 to 1166 mm,  
edged on both sides,  
incl. floor seal in  
014 Stainless steel  
appearance or  
010 Black

**UWR\*-X** 10/16/25/50 mm

Plinth height 70 mm: 862 mm  
Plinth height 100 mm: 892 mm  
Plinth height 150 mm: 942 mm  
Plinth height 200 mm: 992 mm

## Wall shelf units

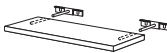

**Plug-in wall shelf,  
25 mm thick**  
Carcass material,  
polymer edging all around,  
255 mm deep,  
incl. metal plug fitting

**WB25** 30/40/45/50/55/  
60/65/70/80/90/  
100/110/120 cm



**Wall shelf unit with shelf  
holders, 16 mm thick**  
255 mm deep,  
polymer edging all round,  
available in widths from  
250 mm to 1000 mm,  
includes 2 shelf holders  
VBH5

**VB16** 100 cm

**VB16** 258 cm

Wall shelf unit with shelf  
holders as above,  
**however available in  
widths from 1001 mm to  
2580 mm,**  
includes 4 shelf holders  
VBH5

**Available shelf holder  
colours:**  
010 Black  
014 Stainless steel  
appearance

## Upright panels for wall units

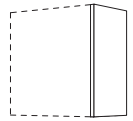

**Upright at end of run /  
intermediate upright for  
wall units,  
height 1**  
depth: 372 mm,  
height: 720 mm

**WW** 10/16/25/50 mm -1

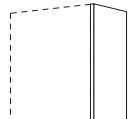

**Upright at end of run /  
intermediate upright for  
wall units,  
height 2**  
depth: 372 mm,  
height: 792 mm

**WW** 10/16/25/50 mm -2

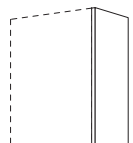

**Upright at end of run /  
intermediate upright for  
wall units,  
height 3**  
depth: 372 mm,  
height: 864 mm

**WW** 10/16/25/50 mm -3

## Top shelves



**Top shelf,  
10 mm thick,  
for side- or highboard**  
coated on both faces,  
polymer edged on front  
and sides,  
length: 250 - 2580 mm

**ADB10** 38/59/117 cm



**Top shelf,  
16 mm thick,  
for side- or highboard**  
coated on both faces,  
polymer edged on front  
and sides,  
length: 250 - 2580 mm

**ADB16** 38/59/117 cm



**Top shelf,  
25 mm thick,  
for side- or highboard**  
coated on both faces,  
polymer edged on front  
and sides,  
length: 250 - 2580 mm

**ADB25** 38/59/117 cm



**Top shelf,  
50 mm thick,  
for side- or highboard**  
coated on both faces,  
polymer edged on front  
and sides,  
length: 250 - 2580 mm

**ADB50** 38/59/117 cm

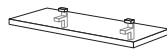

**Wall shelf unit with shelf  
holders, 25 mm thick**  
255 mm deep,  
polymer edging all round,  
available in widths from  
250 mm to 1000 mm,  
includes 2 shelf holders  
VBH5

**VB25** 100 cm

**VB25** 258 cm

Wall shelf unit with shelf  
holders as above,  
**however available in  
widths from 1001 mm to  
2580 mm,**  
includes 4 shelf holders  
VBH5

**Available shelf holder  
colours:**  
010 Black  
014 Stainless steel  
appearance

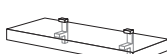

**Wall shelf unit with shelf  
holders, 50 mm thick**  
255 mm deep,  
polymer edging all round,  
available in widths from  
250 mm to 1000 mm,  
includes 2 shelf holders  
VBH5

**VB50** 100 cm

**VB50** 258 cm

Wall shelf unit with shelf  
holders as above,  
**however available in  
widths from 1001 mm to  
2580 mm,**  
includes 4 shelf holders  
VBH5

**Available shelf holder  
colours:**  
010 Black  
014 Stainless steel  
appearance



## Highboards – 1582 / 1612 / 1662 / 1712 mm high

Carcase depth: 561 mm  
 Carcase height: 1512 mm  
 Plinth height: 70, 100, 150 oder 200 mm

## XL Highboards – 1654 / 1684 / 1734 / 1784 mm high

Carcase depth: 561 mm  
 Carcase height: 1584 mm  
 Plinth height: 70, 100, 150 oder 200 mm



### Highboards

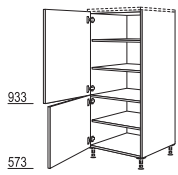

**Highboard**  
 2 doors,  
 1 fixed shelf,  
 3 shelves

H 30/40/50/60 cm

### XL Highboards

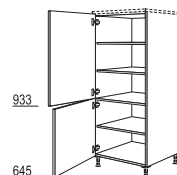

**XL Highboard**  
 2 doors,  
 1 fixed shelf,  
 3 shelves

H\*-X 30/40/50/60 cm

### Housing for ovens

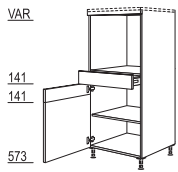

**Oven housing**  
 aperture height: 590 mm  
 1 fixed compensation panel,  
 1 drawer,  
 1 pinned door,  
 1 shelf

GOS

### XL Housing for ovens

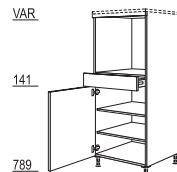

**XL Oven housing**  
 aperture height: 590 mm  
 1 fixed compensation panel,  
 1 drawer,  
 1 door,  
 2 shelves

GDOS-X

### Integrated appliance housings with aperture height up to 880 mm

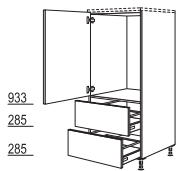

**Appliance housing for integrated fridge**  
 aperture height: 880 mm  
 1 appliance door,  
 2 pull-outs

G88A

### XL Integrated appliance housings with aperture height up to 880 mm

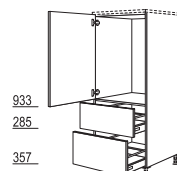

**XL Appliance housing for integrated fridge**  
 aperture height: 880 mm  
 1 appliance door,  
 2 pull-outs

G88A-X

### Integrated appliance housings with aperture height up to 1230 mm

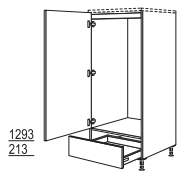

**Appliance housing for integrated fridge**  
 aperture height: 1230 mm  
 1 internal panel,  
 1 appliance door,  
 1 drawer

G123S

### XL Integrated appliance housings with aperture height up to 1230 mm

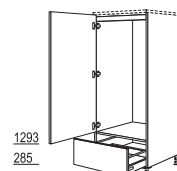

**XL Appliance housing for integrated fridge**  
 aperture height: 1230 mm  
 1 internal panel,  
 1 appliance door,  
 1 pull-out

G123A-X

### Appliance housings with aperture height up to 1450 mm

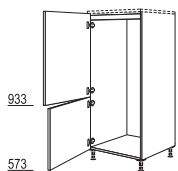

**Appliance housing for integrated fridge / freezer**  
 aperture height: 1450 mm  
 1 internal panel,  
 2 appliance doors

G145

### XL Appliance housings with aperture height up to 1450 mm

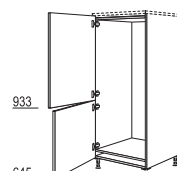

**XL Appliance housing for integrated fridge / freezer**  
 aperture height: 1450 mm  
 2 appliance doors

G145-X

### Fillers

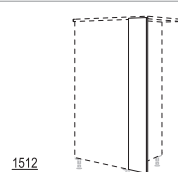

**Filler**  
 Carcase material,  
 1512 mm high,  
 U-shaped seal for  
 connection to wall,  
 width: 230 mm

HPK 20 cm

### XL Fillers

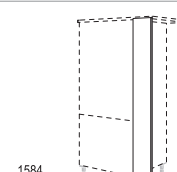

**XL Filler**  
 Carcase material,  
 1584 mm high,  
 U-shaped seal for  
 connection to wall,  
 width: 230 mm

HPK20-X 20 cm

## Tall units, height 1 – 2086 / 2116 / 2166 / 2216 mm high

Carcase depth: 561 mm  
 Carcase height: 2016 mm  
 Plinth height: 70, 100, 150 oder 200 mm

### Tall units

501  
933  
573



**Pantry unit**  
 3 doors,  
 2 fixed shelves,  
 4 shelves

**H\*-1** 30/40/50/60 cm

1293  
717



**Pantry unit**  
 2 doors,  
 1 fixed shelf,  
 4 shelves

**HDV\*-1** 30/40/50/60 cm

501  
933  
573



**Larder unit**  
 1 pull-out with  
 cushioned opening and  
 closing SoftStoppPro,  
 5 hanging baskets with  
 wooden bottoms and  
 metal railing, adjustable

**HA\*-1** 30/40 cm

1293  
717



**Larder unit**  
 1 pull-out with  
 cushioned opening and  
 closing SoftStoppPro,  
 5 hanging baskets with  
 wooden bottoms and  
 metal railing, adjustable

**HDA\*-1** 30/40 cm

501  
933  
573



**Broom cupboard**  
 1 door,  
 1 fixed shelf,  
 1 shelf,  
 1 lug connected door,  
 1 system grid,  
 2 baskets for cleaning  
 materials,  
 1 system shelf,  
 1 hose rack for vacuum  
 cleaner,  
 2 pegboards

**HB\*-1** 40/50/60 cm

501  
933  
573

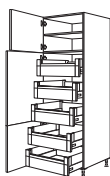

**Tall unit**  
 1 door,  
 1 fixed shelf,  
 1 shelf,  
 1 lug connected door,  
 5 internal pull-outs

**HI\*-1** 40/50/60 cm

### Appliance housing for ovens, microwaves, steam cookers, compact appliances

645  
VAR



**Oven housing**  
 aperture height: 590 mm  
 2 doors,  
 1 fixed compensation panel,  
 2 shelves

717

**GO-1**

645  
VAR



**Oven housing**  
 aperture height: 590 mm  
 2 doors,  
 1 fixed compensation panel,  
 1 drawer,  
 2 shelves

141  
573

**GOS-1**

645  
VAR

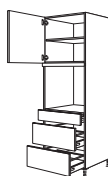

**Oven housing**  
 aperture height: 590 mm  
 1 door,  
 1 shelf,  
 1 fixed compensation panel,  
 1 drawer,  
 2 pull-outs

141  
285  
285

**GOS2A-1**

357  
VAR



**Appliance housing for oven and microwave**  
 aperture height: 380 mm  
 aperture height: 590 mm  
 2 doors,  
 1 fixed compensation panel,  
 1 shelf

573

**GMO-1**

573  
VAR



**Appliance housing for oven and microwave**  
 aperture height: 380 mm  
 aperture height: 590 mm  
 1 door,  
 1 shelf,  
 1 fixed compensation panel,  
 1 pull-out

357

**GMOA-1**

357  
429  
VAR

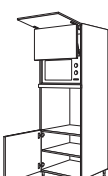

**Appliance housing for oven and microwave with lifting door**  
 aperture height: 370 mm  
 aperture height: 590 mm  
 1 flap,  
 1 lifting door,  
 1 fixed compensation panel,  
 1 door,  
 1 shelf

573

**GLO-1**

357  
429  
VAR

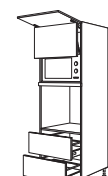

**Appliance housing for oven and microwave with lifting door**  
 aperture height: 370 mm  
 aperture height: 590 mm  
 1 flap,  
 1 lifting door,  
 1 fixed compensation panel,  
 2 pull-outs

285  
285

**GLO2A-1**

### Appliance housings with aperture height up to 880 mm

501  
933  
573



**Appliance housing for integrated fridge**  
 aperture height: 880 mm  
 2 doors,  
 1 appliance door,  
 2 shelves

**G88-1**

357  
933  
717



**Appliance housing for integrated fridge**  
 aperture height: 880 mm  
 1 flap,  
 1 appliance door,  
 1 door,  
 1 shelf

**GD88-1**

501  
933  
285  
285



**Appliance housing for integrated fridge**  
 aperture height: 880 mm  
 1 door,  
 1 shelf,  
 1 appliance door,  
 2 pull-outs

**G88A-1**

### Appliance housings with aperture height up to 1230 mm

1437  
573



**Appliance housing for integrated fridge**  
 aperture height: 1230 mm  
 1 appliance door,  
 1 door,  
 1 shelf

**G123-1**

429  
1293  
285



**Appliance housing for integrated fridge**  
 aperture height: 1230 mm  
 1 door,  
 1 internal panel,  
 1 appliance door,  
 1 pull-out

**G123A-1**

645  
429  
933



**Appliance housing for integrated fridge / freezer**  
 aperture height: 1230 mm  
 1 door,  
 1 shelf,  
 1 internal panel,  
 1 appliance door for  
 freezer compartment,  
 1 appliance door for  
 fridge section

**G123G-1**

## Tall units, height 1 – 2086 / 2116 / 2166 / 2216 mm high

Carcase depth: 561 mm  
 Carcase height: 2016 mm  
 Plinth height: 70, 100, 150 oder 200 mm

### Appliance housings with aperture height up to 1450 mm

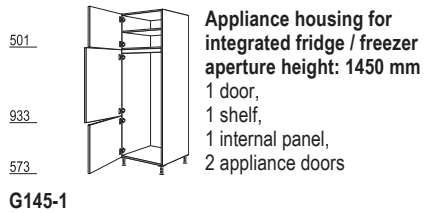
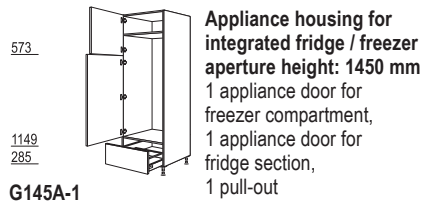

### Fillers / Cladding

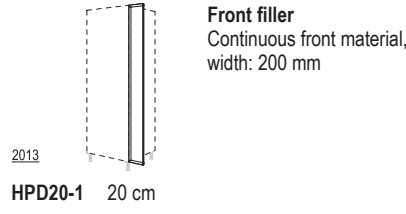
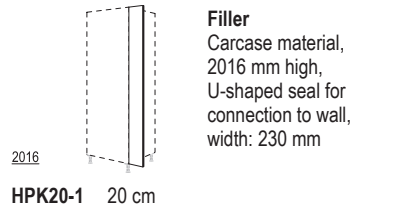

### Appliance housings with aperture height between 1580 - 1940 mm

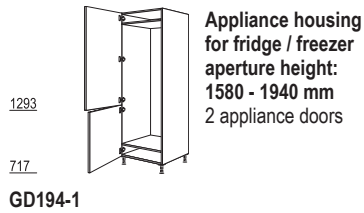

## Tall units in XL height, height 1 XL – 2158 / 2188 / 2238 / 2288 mm high

Carcase depth: 561 mm  
 Carcase height: 2088 mm  
 Plinth height: 70, 100, 150 oder 200 mm



### XL Tall units



H\*-1X 30/40/50/60 cm



HDV\*-1X 30/40/50/60 cm

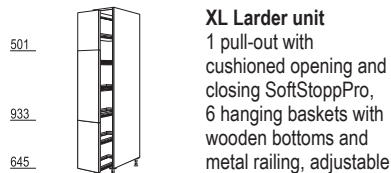

HA\*-1X 30/40 cm

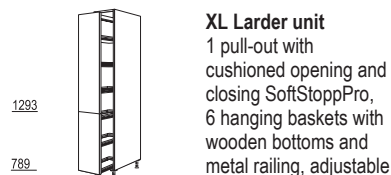

HDA\*-1X 30/40 cm

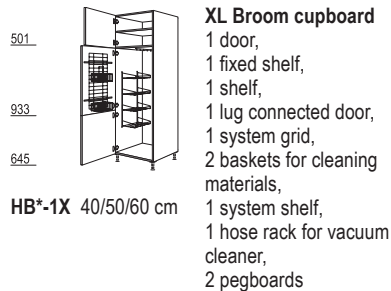

HB\*-1X 40/50/60 cm

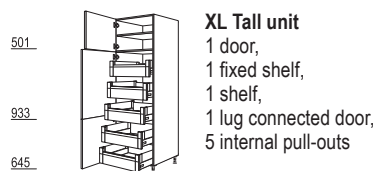

HI\*-1X 40/50/60 cm

### XL Appliance housing for ovens, microwaves, steam cookers, compact appliances



GO-1X



GOS-1X

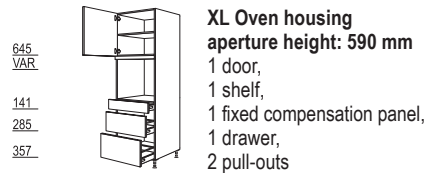

GOS2A-1X

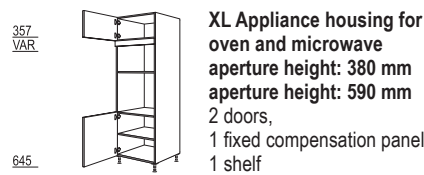

GMO-1X

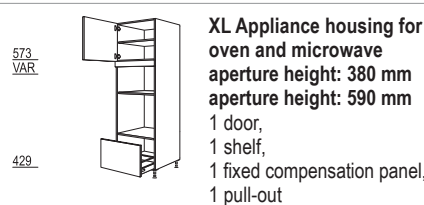

GMOA-1X

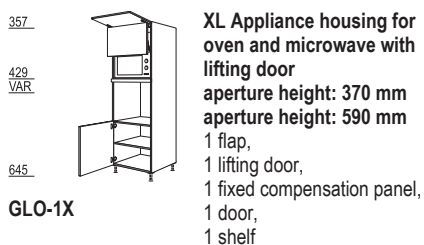

GLO-1X

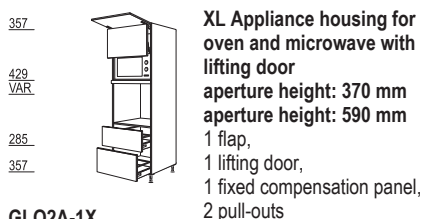

GLO2A-1X

### XL Appliance housings with aperture height up to 880 mm



G88-1X

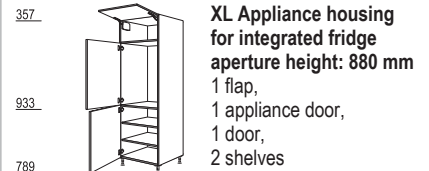

GD88-1X

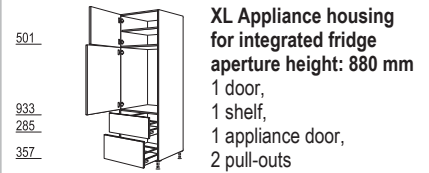

G88A-1X

### XL Appliance housings with aperture height up to 1230 mm

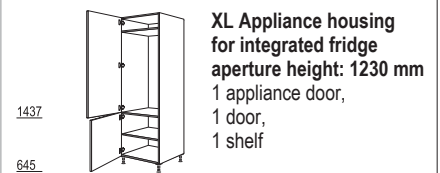

G123-1X

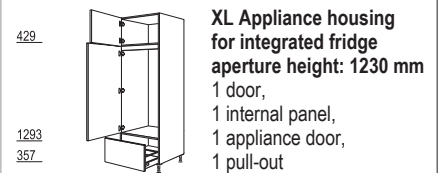

G123A-1X

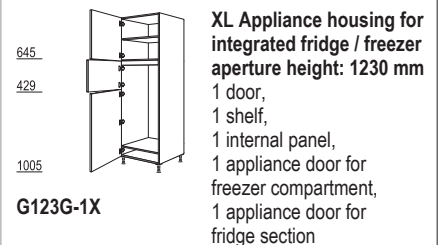

G123G-1X

## Tall units in XL height, height 1 XL – 2158 / 2188 / 2238 / 2288 mm high

Carcase depth: 561 mm  
 Carcase height: 2088 mm  
 Plinth height: 70, 100, 150 oder 200 mm



### XL Appliance housings with aperture height up to 1450 mm

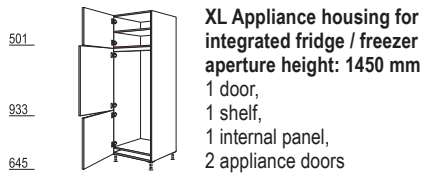

**G145-1X**

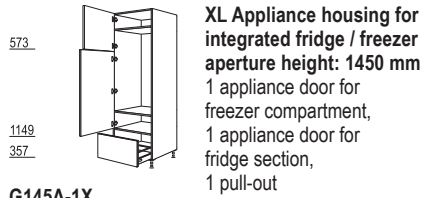

**G145A-1X**

### XL Fillers / Cladding

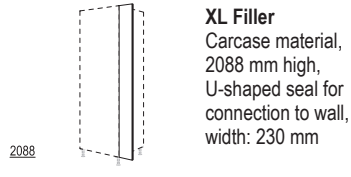

**HPK20-1X 20 cm**

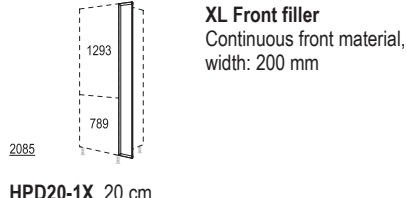

**HPD20-1X 20 cm**

### XL Appliance housings with aperture height between 1580 - 1940 mm

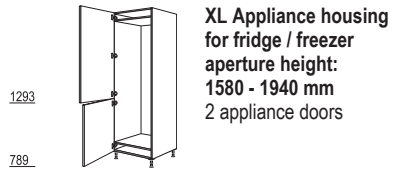

**GD194-1X**



## Tall units, height 2 – 2158 / 2188 / 2238 / 2288 mm high

Carcase depth: 561 mm  
 Carcase height: 2088 mm  
 Plinth height: 70, 100, 150 oder 200 mm

### Tall units

573  
933  
573



**Pantry unit**  
 3 doors,  
 2 fixed shelves,  
 4 shelves

H\*-2 30/40/50/60 cm

1365  
717



**Pantry unit**  
 2 doors,  
 1 fixed shelf,  
 4 shelves

HDV\*-2 30/40/50/60 cm

573  
933  
573



**Larder unit**  
 1 pull-out with  
 cushioned opening and  
 closing SoftStoppPro,  
 6 hanging baskets with  
 wooden bottoms and  
 metal railing, adjustable

HA\*-2 30/40 cm

1365  
717



**Larder unit**  
 1 pull-out with  
 cushioned opening and  
 closing SoftStoppPro,  
 6 hanging baskets with  
 wooden bottoms and  
 metal railing, adjustable

HDA\*-2 30/40 cm

573  
933  
573



**Broom cupboard**  
 1 door,  
 1 fixed shelf,  
 1 shelf,  
 1 lug connected door,  
 1 system grid,  
 2 baskets for cleaning  
 materials,  
 1 system shelf,  
 1 hose rack for vacuum  
 cleaner,  
 2 pegboards

HB\*-2 40/50/60 cm

573  
933  
573

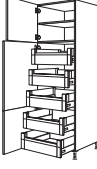

**Tall unit**  
 1 door,  
 1 fixed shelf,  
 1 shelf,  
 1 lug connected door,  
 5 internal pull-outs

HI\*-2 40/50/60 cm

### Appliance housing for ovens, microwaves, steam cookers, compact appliances

717  
VAR



**Oven housing**  
 aperture height: 590 mm  
 2 doors,  
 1 fixed compensation panel,  
 2 shelves

717

GO-2

717  
VAR



**Oven housing**  
 aperture height: 590 mm  
 2 doors,  
 1 fixed compensation panel,  
 1 drawer,  
 2 shelves

141  
573

GOS-2

717  
VAR

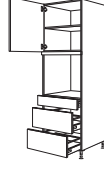

**Oven housing**  
 aperture height: 590 mm  
 1 door,  
 1 shelf,  
 1 fixed compensation panel,  
 1 drawer,  
 2 pull-outs

141  
285  
285

GOS2A-2

429  
VAR



**Appliance housing for  
 oven and microwave**  
 aperture height: 380 mm  
 aperture height: 590 mm  
 2 doors,  
 1 fixed compensation panel,  
 1 shelf

573

GMO-2

645  
VAR



**Appliance housing for  
 oven and microwave**  
 aperture height: 380 mm  
 aperture height: 590 mm  
 1 door,  
 1 shelf,  
 1 fixed compensation panel,  
 1 pull-out

357

GMOA-2

429  
VAR

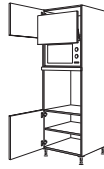

**Appliance housing for  
 oven and microwave with  
 lifting door**  
 aperture height: 370 mm  
 aperture height: 590 mm  
 2 doors,  
 1 lifting door,  
 1 fixed compensation panel,  
 1 shelf

573

GLO-2

429  
VAR

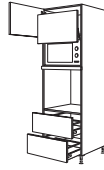

**Appliance housing for  
 oven and microwave with  
 lifting door**  
 aperture height: 370 mm  
 aperture height: 590 mm  
 1 door,  
 1 lifting door,  
 1 fixed compensation panel,  
 2 pull-outs

285  
285

GLO2A-2

### Appliance housings with aperture height up to 880 mm

573  
933  
573



**Appliance housing  
 for integrated fridge**  
 aperture height: 880 mm  
 2 doors,  
 1 appliance door,  
 2 shelves

G88-2

429  
933  
717



**Appliance housing  
 for integrated fridge**  
 aperture height: 880 mm  
 2 doors,  
 1 appliance door,  
 1 shelf

GD88-2

573  
933  
285  
285



**Appliance housing  
 for integrated fridge**  
 aperture height: 880 mm  
 1 door,  
 1 shelf,  
 1 appliance door,  
 2 pull-outs

G88A-2

### Appliance housings with aperture height up to 1230 mm

213  
1293  
573

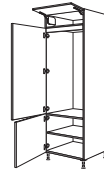

**Appliance housing  
 for integrated fridge**  
 aperture height: 1230 mm  
 1 flap,  
 1 internal panel,  
 1 appliance door,  
 1 door,  
 1 shelf

G123-2

501  
1293  
285



**Appliance housing  
 for integrated fridge**  
 aperture height: 1230 mm  
 1 door,  
 1 shelf,  
 1 internal panel  
 1 appliance door,  
 1 pull-out

G123A-2

717  
429  
933



**Appliance housing for  
 integrated fridge / freezer**  
 aperture height: 1230 mm  
 1 door,  
 1 shelf,  
 1 internal panel,  
 1 appliance door for  
 freezer compartment,  
 1 appliance door for  
 fridge section

G123G-2

## Tall units, height 2 – 2158 / 2188 / 2238 / 2288 mm high

Carcase depth: 561 mm  
 Carcase height: 2088 mm  
 Plinth height: 70, 100, 150 oder 200 mm

### Appliance housings with aperture height up to 1450 mm

429  
933  
717



**Appliance housing for fridge / freezer**  
**aperture height: 1450 mm**  
 1 door,  
 1 internal panel,  
 2 appliance doors

**GD145-2**

573  
933  
573



**Appliance housing for integrated fridge / freezer**  
**aperture height: 1450 mm**  
 1 door,  
 1 shelf,  
 1 internal panel,  
 2 appliance doors,

**G145-2**

### Fillers / Cladding

2088

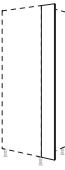

**Filler**  
 Carcase material,  
 2088 mm high,  
 U-shaped seal for  
 connection to wall,  
 width: 230 mm

**HPK20-2 20 cm**

1365  
717  
2085

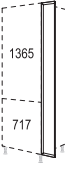

**Front filler**  
 Continuous front material,  
 width: 200 mm

**HPD20-2 20 cm**

### Appliance housings with aperture height between 1580 - 1940 mm

213  
1149  
717

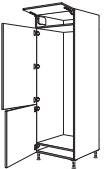

**Appliance housing for fridge / freezer**  
**aperture height: 1780 mm**  
 1 flap,  
 2 appliance doors

**GD178-2**



## Tall units in XL height, height 2 XL – 2230 / 2260 / 2310 / 2360 mm high

Carcase depth: 561 mm  
 Carcase height: 2160 mm  
 Plinth height: 70, 100, 150 oder 200 mm



### XL Tall units

573  
933  
645



**XL Pantry unit**  
 3 doors,  
 2 fixed shelves,  
 4 shelves

**H\*-2X** 30/40/50/60 cm

1365  
789



**XL Pantry unit**  
 2 doors,  
 1 fixed shelf,  
 5 shelves

**HDV\*-2X** 30/40/50/60 cm

573  
933  
645



**XL Larder unit**  
 1 pull-out with  
 cushioned opening and  
 closing SoftStoppPro,  
 6 hanging baskets with  
 wooden bottoms and  
 metal railing, adjustable

**HA\*-2X** 30/40 cm

1365  
789



**XL Larder unit**  
 1 pull-out with  
 cushioned opening and  
 closing SoftStoppPro,  
 6 hanging baskets with  
 wooden bottoms and  
 metal railing, adjustable

**HDA\*-2X** 30/40 cm

573  
933  
645



**XL Broom cupboard**  
 1 door,  
 1 fixed shelf,  
 1 shelf,  
 1 lug connected door,  
 1 system grid,  
 2 baskets for cleaning  
 materials,  
 1 system shelf,  
 1 hose rack for vacuum  
 cleaner,  
 2 pegboards

**HB\*-2X** 40/50/60 cm

573  
933  
645

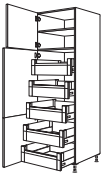

**XL Tall unit**  
 1 door,  
 1 fixed shelf,  
 1 shelf,  
 1 lug connected door,  
 5 internal pull-outs

**HI\*-2X** 40/50/60 cm

### XL Appliance housing for ovens, micro- waves, steam cookers, compact appliances

717  
VAR  
789



**XL Oven housing**  
 aperture height: 590 mm  
 2 doors,  
 1 fixed compensation panel,  
 3 shelves

**GO-2X**

717  
VAR  
141  
645



**XL Oven housing**  
 aperture height: 590 mm  
 2 doors,  
 1 fixed compensation panel,  
 1 drawer,  
 2 shelves

**GOS-2X**

717  
VAR  
141  
285  
357

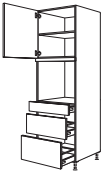

**XL Oven housing**  
 aperture height: 590 mm  
 1 door,  
 1 shelf,  
 1 fixed compensation panel,  
 1 drawer,  
 2 pull-outs

**GOS2A-2X**

429  
VAR  
645



**XL Appliance housing**  
 for oven and microwave  
 aperture height: 380 mm  
 aperture height: 590 mm  
 2 doors,  
 1 fixed compensation panel,  
 1 shelf

**GMO-2X**

429  
VAR  
285  
357

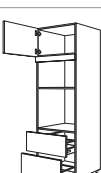

**XL Appliance housing**  
 for oven and microwave  
 aperture height: 380 mm  
 aperture height: 590 mm  
 1 door,  
 1 fixed compensation panel,  
 2 pull-outs

**GMO2A-2X**

429  
429  
VAR  
645

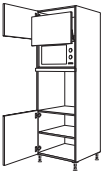

**XL Appliance housing**  
 for oven and microwave with  
 lifting door  
 aperture height: 370 mm  
 aperture height: 590 mm  
 2 doors,  
 1 lifting door,  
 1 fixed compensation panel,  
 1 shelf

**GLO-2X**

429  
429  
VAR  
285  
357

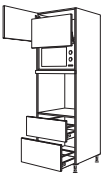

**XL Appliance housing**  
 for oven and microwave with  
 lifting door  
 aperture height: 370 mm  
 aperture height: 590 mm  
 1 door,  
 1 lifting door,  
 1 fixed compensation panel,  
 2 pull-outs

**GLO2A-2X**

### XL Appliance housings with aperture height up to 880 mm

573  
933  
645



**XL Appliance housing**  
 for integrated fridge  
 aperture height: 880 mm  
 2 doors,  
 1 appliance door,  
 2 shelves

**G88-2X**

429  
933  
789



**XL Appliance housing**  
 for integrated fridge  
 aperture height: 880 mm  
 2 doors,  
 1 appliance door,  
 2 shelves

**GD88-2X**

573  
933  
285  
357

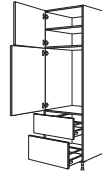

**XL Appliance housing**  
 for integrated fridge  
 aperture height: 880 mm  
 1 door,  
 1 shelf,  
 1 appliance door,  
 2 pull-outs

**G88A-2X**

### XL Appliance housings with aperture height up to 1230 mm

213  
1293  
645

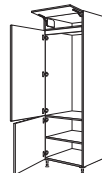

**XL Appliance housing**  
 for integrated fridge  
 aperture height: 1230 mm  
 1 flap,  
 1 internal panel,  
 1 appliance door,  
 1 door,  
 1 shelf

**G123-2X**

501  
1293  
357

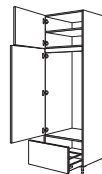

**XL Appliance housing**  
 for integrated fridge  
 aperture height: 1230 mm  
 1 door,  
 1 shelf,  
 1 internal panel  
 1 appliance door,  
 1 pull-out

**G123A-2X**

717  
429  
1005



**XL Appliance housing**  
 for integrated fridge / freezer  
 aperture height: 1230 mm  
 1 door,  
 1 shelf,  
 1 internal panel,  
 1 appliance door for  
 freezer compartment,  
 1 appliance door for  
 fridge section

**G123G-2X**



## Tall units in XL height, height 2 XL – 2230 / 2260 / 2310 / 2360 mm high

Carcase depth: 561 mm  
Carcase height: 2160 mm  
Plinth height: 70, 100, 150 oder 200 mm



### XL Appliance housings with aperture height up to 1450 mm

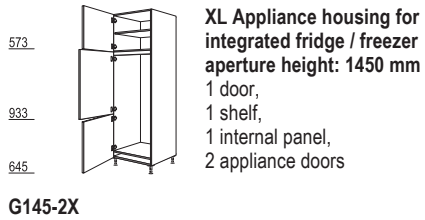
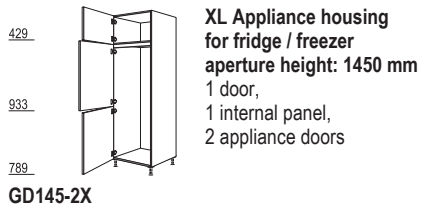

### XL Fillers / Cladding

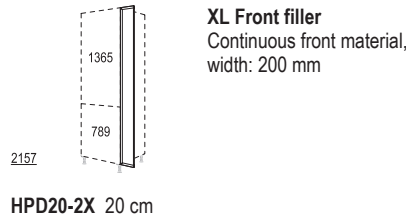
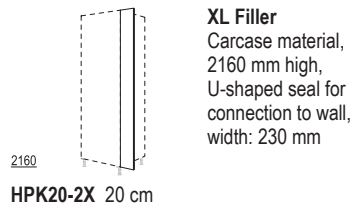

### XL Appliance housings with aperture height between 1580 - 1940 mm

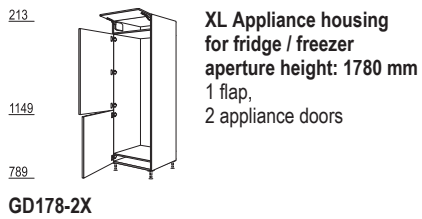

## Tall units, height 3 – 2230 / 2260 / 2310 / 2360 mm high

Carcase depth: 561 mm  
 Carcase height: 2160 mm  
 Plinth height: 70, 100, 150 oder 200 mm

### Tall units



**Pantry unit**  
 3 doors,  
 2 fixed shelves,  
 4 shelves

H\*-3 30/40/50/60 cm



**Pantry unit**  
 2 doors,  
 1 fixed shelf,  
 4 shelves

HDV\*-3 30/40/50/60 cm

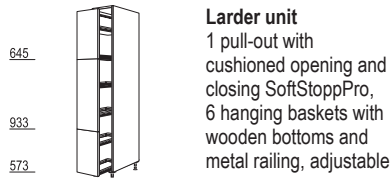

**Larder unit**  
 1 pull-out with  
 cushioned opening and  
 closing SoftStoppPro,  
 6 hanging baskets with  
 wooden bottoms and  
 metal railing, adjustable

HA\*-3 30/40 cm

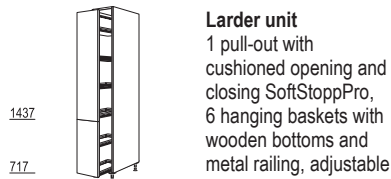

**Larder unit**  
 1 pull-out with  
 cushioned opening and  
 closing SoftStoppPro,  
 6 hanging baskets with  
 wooden bottoms and  
 metal railing, adjustable

HDA\*-3 30/40 cm

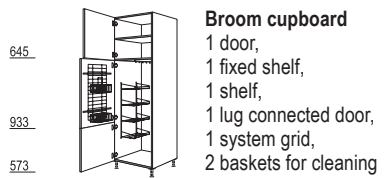

**Broom cupboard**  
 1 door,  
 1 fixed shelf,  
 1 shelf,  
 1 lug connected door,  
 1 system grid,  
 2 baskets for cleaning  
 materials,  
 1 system shelf,  
 1 hose rack for vacuum  
 cleaner,  
 2 pegboards

HB\*-3 40/50/60 cm

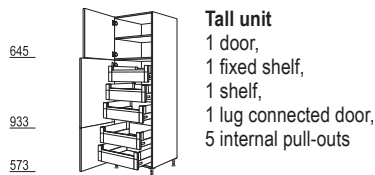

**Tall unit**  
 1 door,  
 1 fixed shelf,  
 1 shelf,  
 1 lug connected door,  
 5 internal pull-outs

HI\*-3 40/50/60 cm

### Appliance housing for ovens, micro-waves, steam cookers, compact appliances



**Oven housing**  
 aperture height: 590 mm  
 2 doors,  
 1 fixed compensation panel,  
 3 shelves

GO-3



**Oven housing**  
 aperture height: 590 mm  
 2 doors,  
 1 fixed compensation panel,  
 1 drawer,  
 3 shelves

GOS-3

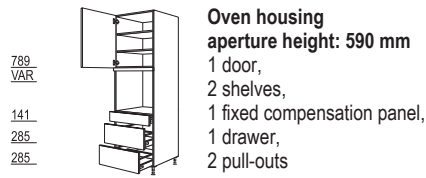

**Oven housing**  
 aperture height: 590 mm  
 1 door,  
 2 shelves,  
 1 fixed compensation panel,  
 1 drawer,  
 2 pull-outs

GOS2A-3

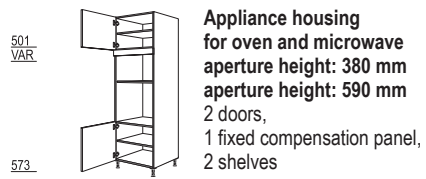

**Appliance housing**  
 for oven and microwave  
 aperture height: 380 mm  
 aperture height: 590 mm  
 2 doors,  
 1 fixed compensation panel,  
 2 shelves

GMO-3



**Appliance housing**  
 for oven and microwave  
 aperture height: 380 mm  
 aperture height: 590 mm  
 1 door,  
 1 shelf,  
 1 fixed compensation panel,  
 1 pull-out

GMOA-3

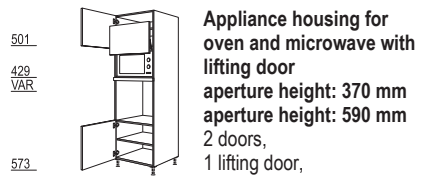

**Appliance housing for**  
 oven and microwave with  
 lifting door  
 aperture height: 370 mm  
 aperture height: 590 mm  
 2 doors,  
 1 lifting door,  
 1 fixed compensation panel,  
 2 shelves

GLO-3

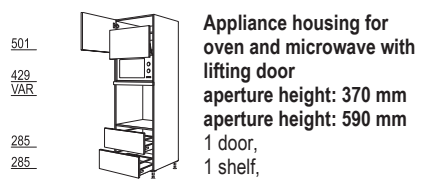

**Appliance housing for**  
 oven and microwave with  
 lifting door  
 aperture height: 370 mm  
 aperture height: 590 mm  
 1 door,  
 1 shelf,  
 1 lifting door,  
 1 fixed compensation panel,  
 2 pull-outs

GLO2A-3

### Appliance housings with aperture height up to 880 mm

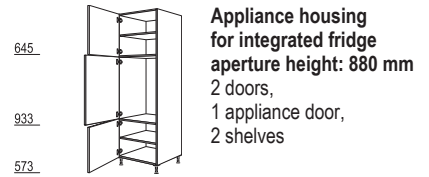

**Appliance housing**  
 for integrated fridge  
 aperture height: 880 mm  
 2 doors,  
 1 appliance door,  
 2 shelves

G88-3

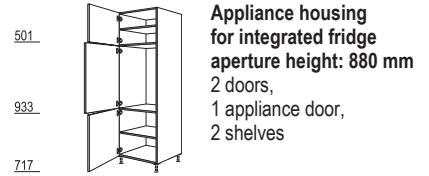

**Appliance housing**  
 for integrated fridge  
 aperture height: 880 mm  
 2 doors,  
 1 appliance door,  
 2 shelves

GD88-3

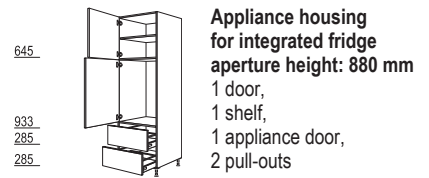

**Appliance housing**  
 for integrated fridge  
 aperture height: 880 mm  
 1 door,  
 1 shelf,  
 1 appliance door,  
 2 pull-outs

G88A-3

### Appliance housings with aperture height up to 1230 mm

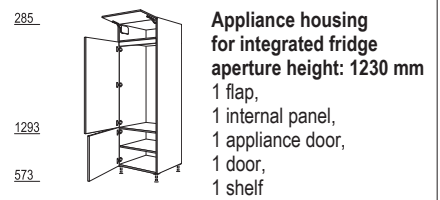

**Appliance housing**  
 for integrated fridge  
 aperture height: 1230 mm  
 1 flap,  
 1 internal panel,  
 1 appliance door,  
 1 door,  
 1 shelf

G123-3

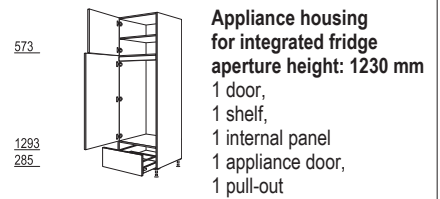

**Appliance housing**  
 for integrated fridge  
 aperture height: 1230 mm  
 1 door,  
 1 shelf,  
 1 internal panel  
 1 appliance door,  
 1 pull-out

G123A-3

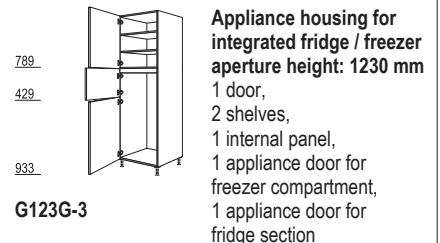

**Appliance housing for**  
 integrated fridge / freezer  
 aperture height: 1230 mm  
 1 door,  
 2 shelves,  
 1 internal panel,  
 1 appliance door for  
 freezer compartment,  
 1 appliance door for  
 fridge section

G123G-3

## Tall units, height 3 – 2230 / 2260 / 2310 / 2360 mm high

Carcase depth: 561 mm  
 Carcase height: 2160 mm  
 Plinth height: 70, 100, 150 oder 200 mm

### Appliance housings with aperture height up to 1450 mm

501  
933  
717  
**GD145-3**



**Appliance housing for fridge / freezer  
aperture height: 1450 mm**  
 1 door,  
 1 shelf,  
 1 internal panel,  
 2 appliance doors

645  
933  
573  
**G145-3**



**Appliance housing for integrated fridge / freezer  
aperture height: 1450 mm**  
 1 door,  
 1 shelf,  
 1 internal panel,  
 2 appliance doors,

### Fillers / Cladding

2160  
**HPK20-3 20 cm**

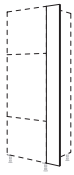

**Filler**  
 Carcase material,  
 2160 mm high,  
 U-shaped seal for  
 connection to wall,  
 width: 230 mm

2157  
**HPD20-3 20 cm**

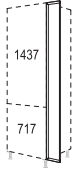

**Front filler**  
 Continuous front material,  
 width: 200 mm

### Appliance housings with aperture height between 1580 - 1940 mm

285  
1149  
717  
**GD178-3**



**Appliance housing for fridge / freezer  
aperture height: 1780 mm**  
 1 flap,  
 2 appliance doors



## Tall units in XL height, height 3 XL – 2302 / 2332 / 2382 / 2432 mm high

Carcase depth: 561 mm  
 Carcase height: 2232 mm  
 Plinth height: 70, 100, 150 oder 200 mm



### XL Tall units

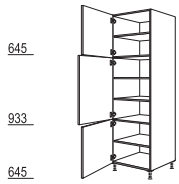

**XL Pantry unit**  
 3 doors,  
 2 fixed shelves,  
 4 shelves

H\*-3X 30/40/50/60 cm



**XL Pantry unit**  
 2 doors,  
 1 fixed shelf,  
 5 shelves

HDV\*-3X 30/40/50/60 cm

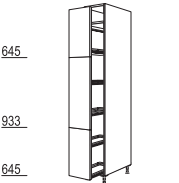

**XL Larder unit**  
 1 pull-out with cushioned opening and closing SoftStoppPro, 5 hanging baskets with wooden bottoms and metal railing, adjustable, 1 fixed shelf

HA\*-3X 30/40 cm

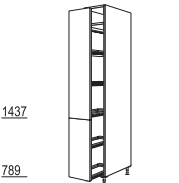

**XL Larder unit**  
 1 pull-out with cushioned opening and closing SoftStoppPro, 5 hanging baskets with wooden bottoms and metal railing, adjustable, 1 fixed shelf

HDA\*-3X 30/40 cm



**XL Broom cupboard**  
 1 door,  
 1 fixed shelf,  
 1 shelf,  
 1 lug connected door,  
 1 system grid,  
 2 baskets for cleaning materials,  
 1 system shelf,  
 1 hose rack for vacuum cleaner,  
 2 pegboards

HB\*-3X 40/50/60 cm

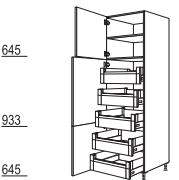

**XL Tall unit**  
 1 door,  
 1 fixed shelf,  
 1 shelf,  
 1 lug connected door,  
 5 internal pull-outs

HI\*-3X 40/50/60 cm

### XL Appliance housing for ovens, micro-waves, steam cookers, compact appliances

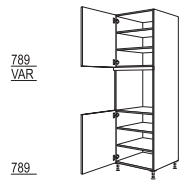

**XL Oven housing**  
 aperture height: 590 mm  
 2 doors,  
 1 fixed compensation panel,  
 4 shelves

GO-3X

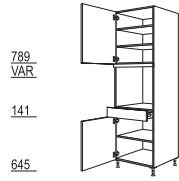

**XL Oven housing**  
 aperture height: 590 mm  
 2 doors,  
 1 fixed compensation panel,  
 1 drawer,  
 3 shelves

GOS-3X

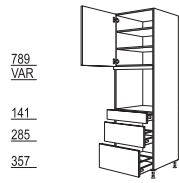

**XL Oven housing**  
 aperture height: 590 mm  
 1 door,  
 2 shelves,  
 1 fixed compensation panel,  
 1 drawer,  
 2 pull-outs

GOS2A-3X

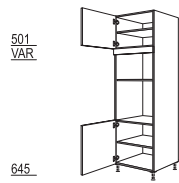

**XL Appliance housing**  
 for oven and microwave  
 aperture height: 380 mm  
 aperture height: 590 mm  
 2 doors,  
 1 fixed compensation panel,  
 2 shelves

GMO-3X

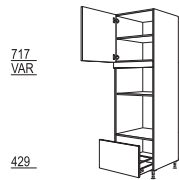

**XL Appliance housing**  
 for oven and microwave  
 aperture height: 380 mm  
 aperture height: 590 mm  
 1 door,  
 1 shelf,  
 1 fixed compensation panel,  
 1 pull-out

GMOA-3X

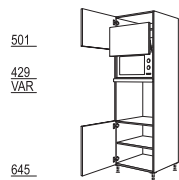

**XL Appliance housing**  
 for oven and microwave with lifting door  
 aperture height: 370 mm  
 aperture height: 590 mm  
 2 doors,  
 1 lifting door,  
 1 fixed compensation panel,  
 2 shelves

GLO-3X

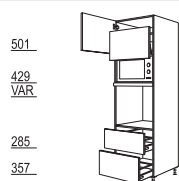

**XL Appliance housing**  
 for oven and microwave with lifting door  
 aperture height: 370 mm  
 aperture height: 590 mm  
 1 door,  
 1 shelf,  
 1 lifting door,  
 1 fixed compensation panel,  
 2 pull-outs

GLO2A-3X

### XL Appliance housings with aperture height up to 880 mm

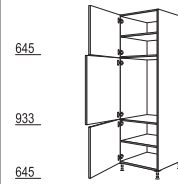

**XL Appliance housing**  
 for integrated fridge  
 aperture height: 880 mm  
 2 doors,  
 1 appliance door,  
 2 shelves

G88-3X

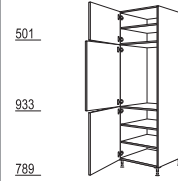

**XL Appliance housing**  
 for integrated fridge  
 aperture height: 880 mm  
 2 doors,  
 1 appliance door,  
 3 shelves

GD88-3X

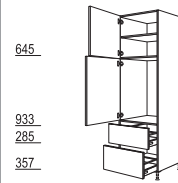

**XL Appliance housing**  
 for integrated fridge  
 aperture height: 880 mm  
 1 door,  
 1 shelf,  
 1 appliance door,  
 2 pull-outs

G88A-3X

### XL Appliance housings with aperture height up to 1230 mm

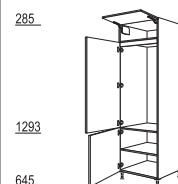

**XL Appliance housing**  
 for integrated fridge  
 aperture height: 1230 mm  
 1 flap,  
 1 internal panel,  
 1 appliance door,  
 1 door,  
 1 shelf

G123-3X

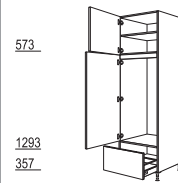

**XL Appliance housing**  
 for integrated fridge  
 aperture height: 1230 mm  
 1 door,  
 1 shelf,  
 1 internal panel,  
 1 appliance door,  
 1 pull-out

G123A-3X

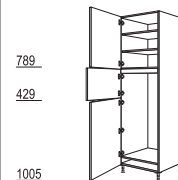

**XL Appliance housing**  
 for integrated fridge / freezer  
 aperture height: 1230 mm  
 1 door,  
 2 shelves,  
 1 internal panel,  
 1 appliance door for freezer compartment,  
 1 appliance door for fridge section

G123G-3X

## Tall units in XL height, height 3 XL – 2302 / 2332 / 2382 / 2432 mm high

Carcase depth: 561 mm  
 Carcase height: 2232 mm  
 Plinth height: 70, 100, 150 oder 200 mm



### XL Appliance housings with aperture height up to 1450 mm

501  
 933  
 789  
**GD145-3X**

**XL Appliance housing for fridge / freezer aperture height: 1450 mm**  
 1 door,  
 1 shelf,  
 1 internal panel,  
 2 appliance doors

645  
 933  
 645  
**G145-3X**

**XL Appliance housing for integrated fridge / freezer aperture height: 1450 mm**  
 1 door,  
 1 shelf,  
 1 internal panel,  
 2 appliance doors,

### XL Fillers / Cladding

2232  
**HPK20-3X 20 cm**

**XL Filler**  
 Carcase material,  
 2232 mm high,  
 U-shaped seal for connection to wall,  
 width: 230 mm

1437  
 789  
 2229  
**HPD20-3X 20 cm**

**XL Front filler**  
 Continuous front material,  
 width: 200 mm

### XL Appliance housings with aperture height between 1580 - 1940 mm

1437  
 789  
**GD194-3X**

**XL Appliance housing for fridge / freezer aperture height: 1580 - 1940 mm**  
 2 appliance doors



## Wall units 360 mm high

Carcase depth: 350 mm  
Carcase height: 360 mm

### Wall units 360 mm high

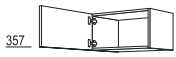

**Wall unit**  
1 door

**W\*-36**  
45/50/60 cm

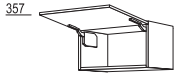

**Wall unit with flap door**  
1 flap,  
opening angle 107°

**WK\*-36**  
45/50/60/80/90/100/  
120 cm

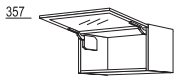

**Wall unit with framed glass flap door**  
1 framed glass flap door,  
clear glass No. 01,  
opening angle 107°,  
glass variants against  
surcharge: no. 02 / 39

**WKG\*-36**  
50/60/80/90/100/  
120 cm

No image

**Surcharge for different glass choice**  
for glass variants:  
No. 02 Matt glass  
No. 39 Black glass

**MP-GW**

### Wall units 360 mm high



**Wall unit with glass doors Square**  
1 aluminium framed flap,  
opening angle 107°,  
handleless version with wall  
unit bottom shelf with  
attached profile strip in  
stainless steel appearance

**WKSQ\*-36**  
50/60/80/90/100/  
120 cm

**Available in:**  
No. 321 Aluminium framed  
front in stainless steel  
appearance with  
02 Matt glass  
No. 308 Aluminium framed  
front in stainless steel  
appearance with  
035 Grey glass  
No. 329 Aluminium framed  
front in Black with  
39 Black glass

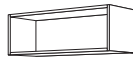

**Open shelf wall unit**  
side depth: 371 mm

**WR\*-36**  
30/40/45/50/60/80/90/  
100/120 cm

### Fillers

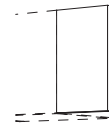

**Filler**  
Carcase material,  
360 mm high,  
U-shaped seal for  
connection to wall,  
width: 100 mm / 200 mm

**WPK\*-36**  
10/20 cm

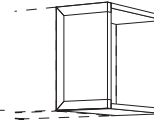

**Front filler**  
Continuous front material,  
2 shelves top and bottom,  
1 wall unit side panel:  
350 mm deep,  
width: 200 mm

**WPD20-36**  
20 cm



## Wall units 576 mm high

Carcase depth: 350 mm  
Carcase height: 576 mm

### Wall units 576 mm high

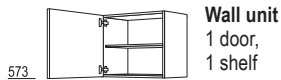

573

**Wall unit**  
1 door,  
1 shelf

**W\*-58**  
20/30/35/40/45/50/60 cm

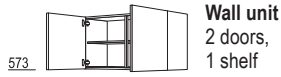

573

**Wall unit**  
2 doors,  
1 shelf

**W2T-58** 60 cm  
**W\*-58** 80/90/100/120 cm



573

**Wall unit**  
2 doors hinged  
parallel,  
1 shelf

**W2TP\*-58**  
80/90/100 cm

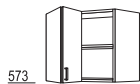

573

**Wall unit**  
1 folding door with slide  
mechanism,  
1 shelf

**WFT60-58**  
60 cm

### Wall units 576 mm high

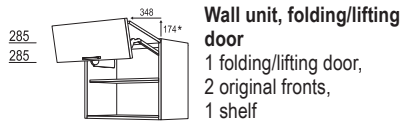

285  
285

**Wall unit, folding/lifting  
door**  
1 folding/lifting door,  
2 original fronts,  
1 shelf

**WFL\*-58**  
50/60/80/90/100/120 cm

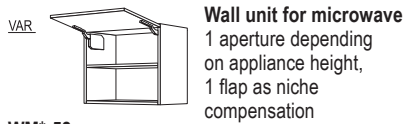

VAR

**WM\*-58**  
50/60 cm

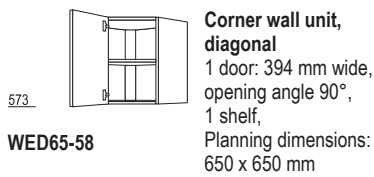

573

**Corner wall unit,  
diagonal**  
1 door: 394 mm wide,  
opening angle 90°,  
1 shelf,  
Planning dimensions:  
650 x 650 mm

**WED65-58**

### Wall units 576 mm high

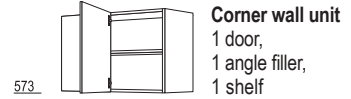

573

**Corner wall unit**  
1 door,  
1 angle filler,  
1 shelf

**Carcase widths:**  
600, 782, 882 mm

**Planning dimensions  
(variable):**  
450 (390 - 500) x ...  
WE60-20: ...650 (630 - 700) mm  
WE80-35: ...800 (790 - 850) mm  
WE90-45: ...900 (890 - 950) mm

**WE60-20-58**  
**WE80-35-58**  
**WE90-45-58**

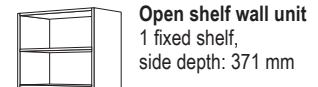

**WR\*-58**  
15/20/30/40/45/50/60 cm

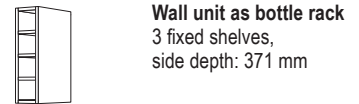

**WRF15-58**  
15 cm

### Fillers



**WPK\*-58**  
10/20 cm

**Filler**  
Carcase material,  
576 mm high,  
U-shaped seal for  
connection to wall,  
width: 100 mm / 200 mm

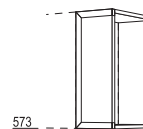

**WPD20-58**  
20 cm

**Front filler**  
Continuous front material,  
2 shelves top and bottom,  
1 wall unit side panel:  
350 mm deep,  
width: 200 mm

## Wall units, height 1 – 720 mm high

Carcase depth: 350 mm  
Carcase height: 720 mm

### Wall units 720 mm high

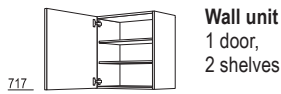

717

**Wall unit**  
1 door,  
2 shelves

**W\*-1**  
20/25/30/35/40/45/50/55/60 cm



717

**Wall unit**  
2 doors,  
2 shelves

**W2T-1** 60 cm  
**W\*-1** 80/90/100 cm



717

**Wall unit**  
2 doors hinged  
parallel,  
2 shelves

**W2TP\*-1**  
80/90/100 cm



717

**Wall unit**  
1 folding door with slide  
mechanism,  
2 shelves

**WFT60-1**  
60 cm

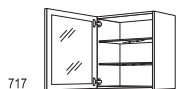

717

**Wall unit,  
framed glass door**  
1 door,  
clear glass No. 01,  
2 glass shelves,  
glass variants against  
surcharge: no. 02 / 39

**WG\*-1**  
45/50/60 cm

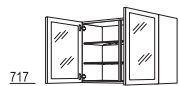

717

**Wall unit,  
framed glass door**  
2 doors,  
clear glass No. 01,  
2 glass shelves,  
glass variants against  
surcharge: no. 02 / 39

**WG\*-1**  
90/100 cm



357

**Wall unit,  
segmented glass door**  
1 door,  
clear glass No. 01,  
2 glass shelves,  
glass variants against  
surcharge: no. 02 / 39

**WGLS\*-1**  
45/50/60 cm

141

### Wall units 720 mm high



357

141

**Wall unit,  
segmented glass door**  
2 doors,  
clear glass No. 01,  
2 glass shelves,  
glass variants against  
surcharge: no. 02 / 39

**WGLS\*-1**  
90/100 cm

**No image**

**MP-GW**

**Surcharge for different  
glass choice**  
for glass variants:  
No. 02 Matt glass  
No. 39 Black glass

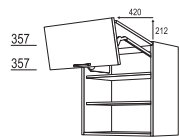

357

357

**Wall unit, folding/lifting  
door**  
1 folding/lifting door,  
2 original fronts,  
2 shelves

**WFL\*-1**  
50/60/80/90/100/120 cm

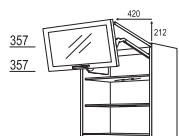

357

357

**Wall unit, folding/lifting door**  
1 folding/lifting door,  
1 top original front,  
1 bottom framed glass front,  
clear glass No. 01,  
2 glass shelves,  
glass variants against  
surcharge: no. 02 / 39

**WFLG\*-1**  
50/60/80/90/100/120 cm



VAR

**Wall unit for microwave**  
1 aperture depending  
on appliance height,  
1 flap as niche  
compensation

**WM\*-1**  
50/60 cm

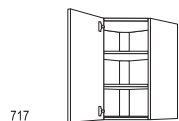

717

**Corner wall unit,  
diagonal**  
1 door: 394 mm wide,  
opening angle 90°,  
2 shelves,  
Planning dimensions:  
650 x 650 mm

**WED65-1**

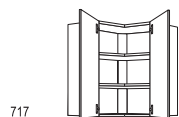

717

**Corner wall unit**  
2 doors  
with 165° hinges,  
2 shelves,  
hinged side = first  
door to be opened

**WE\*-1**  
60/65/80/90 cm

### Wall units 720 mm high



717

**Corner wall unit**  
1 door,  
1 angle filler,  
2 shelves  
Carcase widths:  
600, 782, 882 mm

**WE60-20-1**  
**WE80-35-1**  
**WE90-45-1**

Planning dimensions  
(variable):  
450 (390 - 500) x ...  
WE60-20: ...650 (630 - 700) mm  
WE80-35: ...800 (790 - 850) mm  
WE90-45: ...900 (890 - 950) mm



**WR\*-1**  
15/20/30/40/45/50/60 cm

**Open shelf wall unit**  
2 fixed shelves,  
side depth: 371 mm



**WRF15-1**  
15 cm

**Wall unit as bottle rack**  
4 fixed shelves,  
side depth: 371 mm

### Fillers



**WPK\*-1**  
10/20 cm

**Filler**  
Carcase material,  
720 mm high,  
U-shaped seal for  
connection to wall,  
width: 100 mm / 200 mm

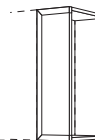

**WPD20-1**  
20 cm

**Front filler**  
Continuous front material,  
2 shelves top and bottom,  
1 wall unit side panel:  
350 mm deep,  
width: 200 mm



## Wall units, height 2 – 792 mm high

Carcase depth: 350 mm  
Carcase height: 792 mm

### Wall units 792 mm high

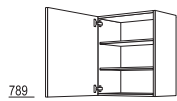

**Wall unit**  
1 door,  
2 shelves

789

**W\*-2** 20/25/30/35/40/45/50/55/60 cm



**Wall unit**  
2 doors,  
2 shelves

789

**W2T\*-2** 60 cm  
**W\*-2** 80/90/100 cm



**Wall unit**  
2 doors hinged  
parallel,  
2 shelves

789

**W2TP\*-2**  
80/90/100 cm



**Wall unit**  
1 folding door with slide  
mechanism,  
2 shelves

789

**WFT60-2**  
60 cm

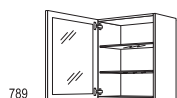

**Wall unit,  
framed glass door**  
1 door,  
clear glass No. 01,  
2 glass shelves,  
glass variants against  
surcharge: no. 02 / 39

789

**WG\*-2**  
45/50/60 cm

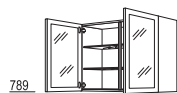

**Wall unit,  
framed glass door**  
2 doors,  
clear glass No. 01,  
2 glass shelves,  
glass variants against  
surcharge: no. 02 / 39

789

**WG\*-2**  
90/100 cm



**Wall unit,  
segmented glass door**  
1 door,  
clear glass No. 01,  
2 glass shelves,  
glass variants against  
surcharge: no. 02 / 39

429

141

**WGLS\*-2**  
45/50/60 cm



**Wall unit,  
segmented glass door**  
2 doors,  
clear glass No. 01,  
2 glass shelves,  
glass variants against  
surcharge: no. 02 / 39

429

141

**WGLS\*-2**  
90/100 cm

**No image**

**Surcharge for different  
glass choice**  
for glass variants:  
No. 02 Matt glass  
No. 39 Black glass

**MP-GW**

### Wall units 792 mm high

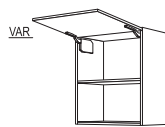

**Wall unit for microwave**  
1 aperture depending  
on appliance height,  
1 flap as niche  
compensation

VAR

**WM\*-2**  
50/60 cm



**Corner wall unit,  
diagonal**  
1 door: 394 mm wide,  
opening angle 90°,  
2 shelves,  
Planning dimensions:  
650 x 650 mm

789

**WED65-2**



**Corner wall unit**  
2 doors  
with 165° hinges,  
2 shelves,  
hinged side = first  
door to be opened

789

**WE\*-2**  
60/65/80/90 cm



**Corner wall unit**  
1 door,  
1 angle filler,  
2 shelves  
Carcass widths:  
600, 782, 882 mm

789

**WE60-20-2**  
**WE80-35-2**  
**WE90-45-2**

Planning dimensions  
(variable):  
450 (390 - 500) x ...  
WE60-20: ...650 (630 - 700) mm  
WE80-35: ...800 (790 - 850) mm  
WE90-45: ...900 (890 - 950) mm



**Open shelf wall unit**  
2 fixed shelves,  
side depth: 371 mm

**WR\*-2**  
15/20/30/40/45/50/60 cm



**Wall unit as bottle rack**  
4 fixed shelves,  
side depth: 371 mm

**WRF15-2**  
15 cm

### Wall units 792 mm high

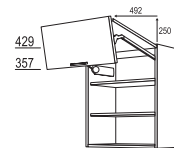

**Wall unit,  
folding/lifting door**  
1 folding/lifting door,  
2 original fronts,  
2 shelves

429

357

**WFL\*-2**  
50/60/80/90/100/120 cm

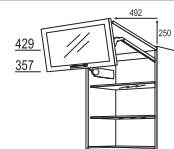

**Wall unit,  
folding/lifting door**  
1 folding/lifting door,  
1 top original front,  
1 bottom framed glass front,  
clear glass No. 01,  
2 glass shelves,  
glass variants against  
surcharge: no. 02 / 39

429

357

**WFLG\*-2**  
50/60/80/90/100/120 cm

### Fillers



**Filler**  
Carcass material,  
792 mm high,  
U-shaped seal for  
connection to wall,  
width: 100 mm / 200 mm

**WPK\*-2**  
10/20 cm

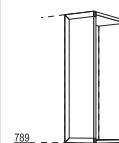

**Front filler**  
Continuous front material,  
2 shelves top and bottom,  
1 wall unit side panel:  
350 mm deep,  
width: 200 mm

789

**WPD20-2**  
20 cm

## Wall units, height 3 – 864 mm high

Carcase depth: 350 mm  
Carcase height: 864 mm

### Wall units 864 mm high



861 **Wall unit**  
1 door,  
2 shelves  
**W\*3** 20/25/30/35/40/45/50/55/60 cm

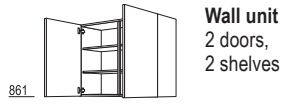

861 **Wall unit**  
2 doors,  
2 shelves  
**W2T\*3** 60 cm  
**W\*3** 80/90/100 cm



861 **Wall unit**  
2 doors hinged  
parallel,  
2 shelves  
**W2TP\*3**  
80/90/100 cm

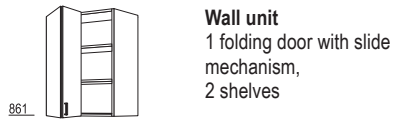

861 **Wall unit**  
1 folding door with slide  
mechanism,  
2 shelves  
**WFT60-3**  
60 cm

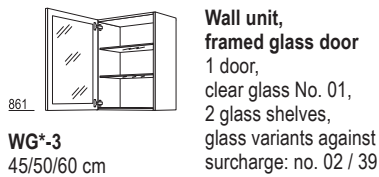

861 **Wall unit, framed glass door**  
1 door,  
clear glass No. 01,  
2 glass shelves,  
glass variants against  
surcharge: no. 02 / 39  
**WG\*3**  
45/50/60 cm

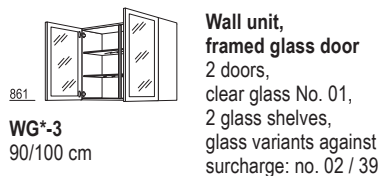

861 **Wall unit, framed glass door**  
2 doors,  
clear glass No. 01,  
2 glass shelves,  
glass variants against  
surcharge: no. 02 / 39  
**WG\*3**  
90/100 cm

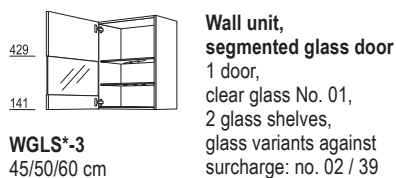

429 861 **Wall unit, segmented glass door**  
1 door,  
clear glass No. 01,  
2 glass shelves,  
glass variants against  
surcharge: no. 02 / 39  
**WGLS\*3**  
45/50/60 cm

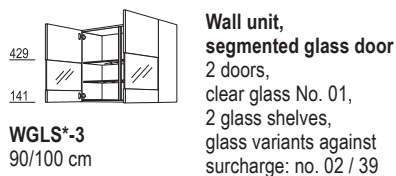

429 861 **Wall unit, segmented glass door**  
2 doors,  
clear glass No. 01,  
2 glass shelves,  
glass variants against  
surcharge: no. 02 / 39  
**WGLS\*3**  
90/100 cm

**No image** **Surcharge for different glass choice**  
for glass variants:  
No. 02 Matt glass  
No. 39 Black glass  
**MP-GW**

### Wall units 864 mm high

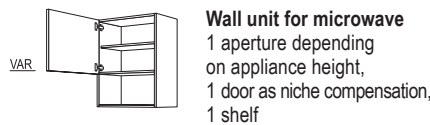

VAR **Wall unit for microwave**  
1 aperture depending  
on appliance height,  
1 door as niche compensation,  
1 shelf  
**WM\*3**  
50/60 cm

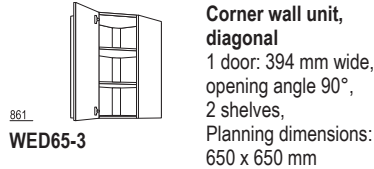

861 **Corner wall unit, diagonal**  
1 door: 394 mm wide,  
opening angle 90°,  
2 shelves,  
Planning dimensions:  
650 x 650 mm  
**WED65-3**

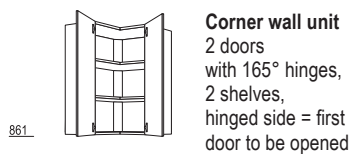

861 **Corner wall unit**  
2 doors  
with 165° hinges,  
2 shelves,  
hinged side = first  
door to be opened  
**WE\*3**  
60/65/80/90 cm

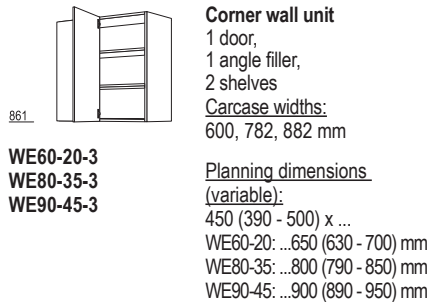

861 **Corner wall unit**  
1 door,  
1 angle filler,  
2 shelves  
Carcass widths:  
600, 782, 882 mm  
**WE60-20-3**  
**WE80-35-3**  
**WE90-45-3**

Planning dimensions  
(variable):  
450 (390 - 500) x ...  
WE60-20: ...650 (630 - 700) mm  
WE80-35: ...800 (790 - 850) mm  
WE90-45: ...900 (890 - 950) mm

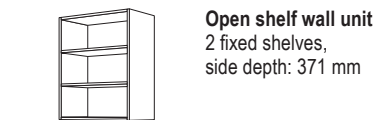

**Open shelf wall unit**  
2 fixed shelves,  
side depth: 371 mm  
**WR\*3**  
15/20/30/40/45/50/60 cm

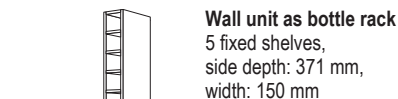

**Wall unit as bottle rack**  
5 fixed shelves,  
side depth: 371 mm,  
width: 150 mm  
**WRF15-3**  
15 cm

## Wall units for cooker hoods

### Wall units for cooker hoods

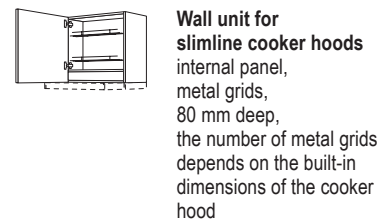

**Wall unit for slimline cooker hoods**  
internal panel,  
metal grids,  
80 mm deep,  
the number of metal grids  
depends on the built-in  
dimensions of the cooker  
hood  
**WDAF60-58** 60 cm height: 576 mm

**WDAF60-1** 60 cm height: 720 mm

**WDAF60-2** 60 cm height: 792 mm

**WDAF60-3** 60 cm height: 864 mm

### Bridging shelf

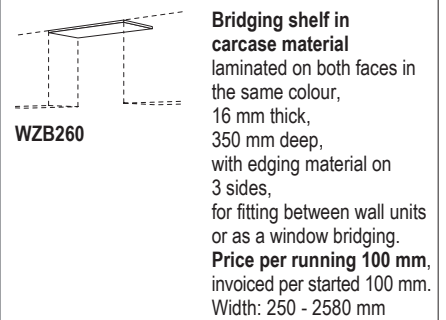

**Bridging shelf in carcass material**  
laminated on both faces in  
the same colour,  
16 mm thick,  
350 mm deep,  
with edging material on  
3 sides,  
for fitting between wall units  
or as a window bridging.  
**Price per running 100 mm,**  
invoiced per started 100 mm.  
Width: 250 - 2580 mm  
**WZB260**

**WZB60** Bridging shelf in carcass  
material as above,  
**however 600 mm wide**

### Fillers

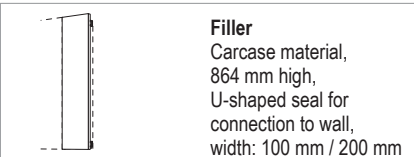

**Filler**  
Carcass material,  
864 mm high,  
U-shaped seal for  
connection to wall,  
width: 100 mm / 200 mm  
**WPK\*3**  
10/20 cm

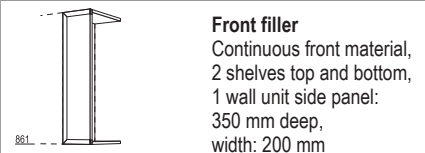

**Front filler**  
Continuous front material,  
2 shelves top and bottom,  
1 wall unit side panel:  
350 mm deep,  
width: 200 mm  
**WPD20-3**  
20 cm

Plastic cutlery trays and pull-out organisers



**Cutlery tray Trend**  
grey, height: 43 mm,  
fits drawer depth of 500 mm,  
side depth: 561 mm

**BE\***  
30/40/45/50/60/80/  
90/100/120 cm

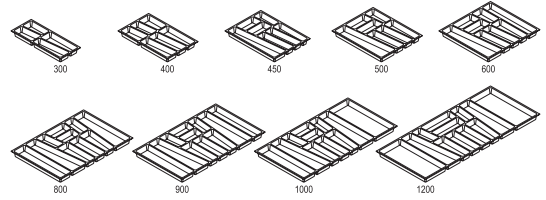

**BE\* -46**  
45/50/60/80/90/  
100/120 cm

**as above**, however for drawer depth 400 mm,  
side depth: 461 mm

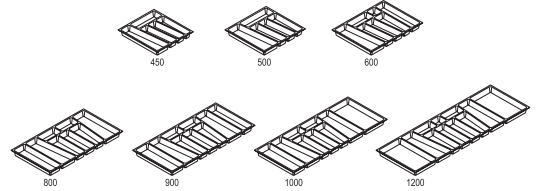

**Cutlery tray Move**  
silver-grey, with dividers for customisable divisions,  
height: 47 mm,  
fits drawer depth of 500 mm,  
side depth: 561 mm

**BE\* M**  
30/40/45/50/60/80/  
90/100/120 cm

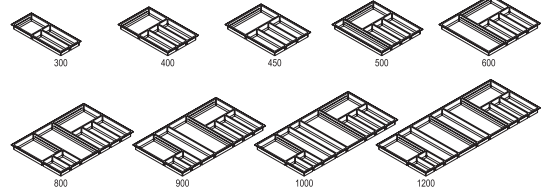

**BE\* -46 M**  
30/40/45/50/60/80/  
90/100/120 cm

**as above**, however for drawer depth 400 mm,  
side depth: 461 mm

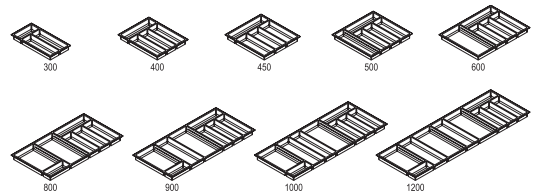

**Universal organiser**  
Alu profile with 4 dividers for individualised divisions, height: 125 mm, fits pull-out depth of 500 mm,  
side depth: 561 mm,  
1 alu profile of 600 mm width,  
2 alu profiles of 800 up to 900 mm width,  
3 alu profiles of 1000 up to 1200 mm width

**AUO 56**

*Please order the correct number for the unit width!*

**AUO 46**

**as above**, however for pull-out depth 400 mm,  
side depth: 461 mm



**Cutlery tray Concept**  
Non-slip soft touch surface,  
anthracite, height: 52 mm, fits drawer depth of 500 mm,  
side depth: 561 mm

**BE\* C**  
30/40/45/50/60/80/  
90/100/120 cm

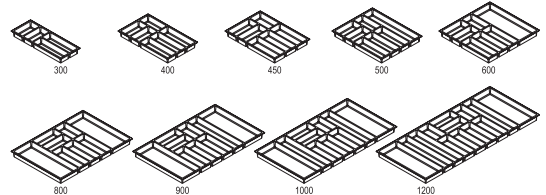

**Pull-out organisation concept**  
Non-slip soft touch surface,  
anthracite, height: 100 mm, fits pull-out depth of 500 mm,  
side depth: 561 mm

**AO\* C**  
60/80/90/100/120 cm

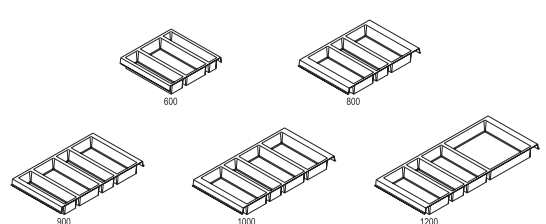

## Accessories

### Plastic cutlery trays and pull-out organisers



**Cutlery tray black edition**  
Non-slip soft touch surface,  
black, height: 52 mm,  
fits drawer depth 500 mm,  
side depth: 561 mm

BE\* BE  
30/40/45/50/60/80/  
90/100/120 cm

black  
edition

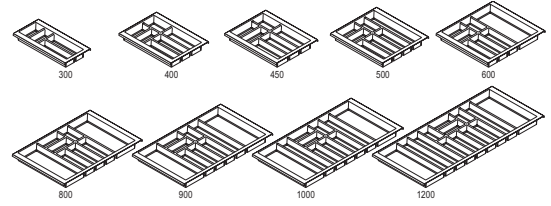

### Black ash cutlery trays and pull-out organisers

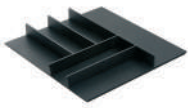

**Black ash wood cutlery tray**  
solid ash wood, stained black,  
height: 56 mm, fits drawer depth of 500 mm,  
side depth: 561 mm

BE\* N  
30/40/45/50/60/80/  
90/100/120 cm

black  
edition

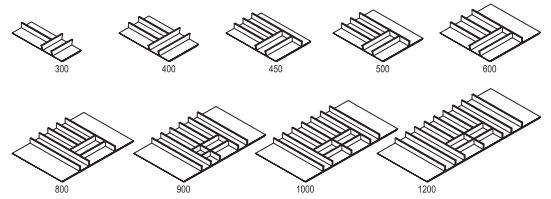

**Black ash wood cutlery tray with knife block,  
storage containers and insert for spice mills and shakers**  
Design in solid ash wood, stained black,  
incl. 5 knives, 6 storage containers, 3 spice mills, 3 shakers,  
height: 56 mm, fits drawer depth 500 mm,  
side depth: 561 mm

BE-MVGS\* N  
80/90/100/120 cm

black  
edition

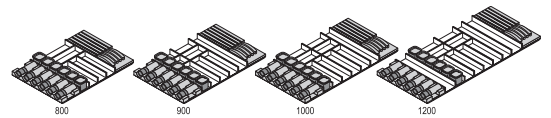

**Universal organiser, black ash**  
with solid wood partitions for individualised divisions,  
fits pull-out depth 500 mm, side depth: 561 mm,  
incl. 8 solid wood partitions in ash for 600 mm width,  
incl. 16 solid wood partitions in ash for 800/900/1000 mm width,  
incl. 24 solid wood partitions in ash for 1200 mm width

AO\* N  
60/80/90/100/120 cm

black  
edition



**Universal organiser, black ash**  
with solid wood partitions for individualised divisions,  
fits pull-out depth 500 mm, side depth: 561 mm,  
incl. 7 solid wood partitions in ash for 600 mm width,  
incl. 10 solid wood partitions in ash for 800/900/1000 mm width,  
incl. 13 solid wood partitions in ash for 1200 mm width

AOS\* N  
60/80/90/100/120 cm

black  
edition



## Accessories

### Beech cutlery trays and pull-out organisers



#### Beech wood cutlery tray

solid beech wood,  
height: 56 mm, fits drawer depth of 500 mm,  
side depth: 561 mm

**BE\* H**  
30/40/45/50/60/80/  
90/100/120 cm

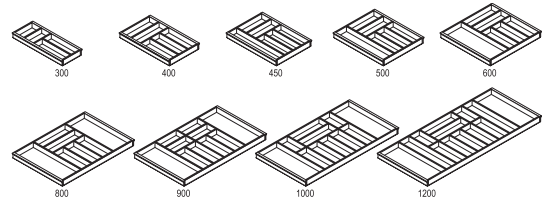

#### Beech wood universal organiser

with solid wood partitions for individualised divisions,  
fits pull-out depth 500 mm,  
side depth: 561 mm,  
incl. 7 solid wood partitions in beech for 600 mm width,  
incl. 10 solid wood partitions in beech for 800 / 900 / 1000 mm width,  
incl. 13 solid wood partitions in beech for 1200 mm width

**AOS\* H**  
60/80/90/100/120 cm

### Oak cutlery trays and pull-out organisers



#### Oak wooden segment cutlery tray

solid wood design in oak,  
**with anti-slip mat in anthracite,**  
height: 55 mm, segment width: 274 mm,  
fits drawer depth of 500 mm,  
side depth: 561 mm,  
one wooden segment is delivered up to a width of 600 mm,  
for widths exceeding 800 mm, two wooden segments are delivered

**BEHS\* E**  
40/45/50/60/80/90/  
100/120 cm

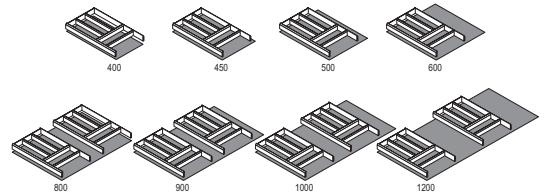

**BEHS\* -46 E**  
40/45/50/60/80/90/  
100/120 cm

**as above,** however for drawer depth 400 mm,  
side depth: 461 mm

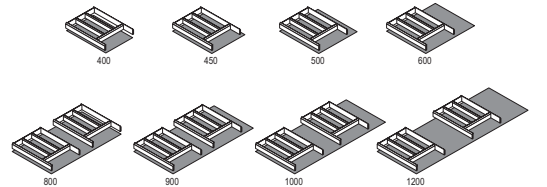

#### Universal organiser, oak

with solid wood partitions for individualised divisions,  
fits pull-out depth 500 mm,  
side depth: 561 mm,  
incl. 7 solid wood partitions in oak for 600 mm width,  
incl. 10 solid wood partitions in oak for 800 / 900 / 1000 mm width,  
incl. 13 solid wood partitions in oak for 1200 mm width

**AOS\* E**  
60/80/90/100/120 cm



## Accessories

### Mounting sets



MONSET 1

#### Mounting set 1

consisting of:

- 1 ball siphon 1 ½" with 40 mm drain white
- 1 space-saving connector white
- 1 HT bend DN 40/87 grey
- 1 HT tube DN 40 x 250 mm grey
- 1 HT transition element DN 40 / 50 mm grey
- 1 cooker connection cable, 5 x 2.5 mm<sup>2</sup>, 2000 mm long
- 2 flex hoses acc. to KTW-A, 300 mm long, 3/8" x 10 mm with union nut



MONSET 2

#### Mounting set 2

consisting of:

- 1 ball siphon 1 ½" with 40 mm drain white
- 1 space-saving connector white
- 1 HT bend DN 40/87 grey
- 1 HT tube DN 40 x 250 mm grey
- 1 HT transition element DN 40 / 50 mm grey
- 1 cooker connection cable, 5 x 2.5 mm<sup>2</sup>, 2000 mm long
- 2 flex hoses acc. to KTW-A, 300 mm long, 3/8" x 10 mm with union nut
- 1 hose clip, 16 - 25 mm
- 1 table socket, triple, sockets - model F, with contact protection, white with 1500 mm supply line, 3 x 1.5 mm<sup>2</sup>

### Accessories for sink units

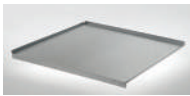

FB\*

40/45/50/60/80/90/  
100/120 cm

#### Moisture protection sheet

aluminium sheet, serrated, for sink base units, cannot be used with front pull-outs, fits only for a side depth of 561 mm

- FB90:** also fits corner sink units SPUE(D)90-45(-X) and NSPUE90-45(-X)  
**FB100:** also fits corner sink units SPUE(D)100-50(-X) and NSPUE100-50(-X)



WSMS\*

40/45/50/60/80/90/  
100/120 cm

#### Waterproof mat

plastic, slate grey, for sink base units, not for use with front pull-outs, fits only side depth of 561 mm

*Not possible in conjunction with hose and cable feed-through SKD or with opening support mechanism Libero AOUL.*

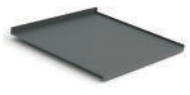

WSMP\*

60/80 cm

#### Waterproof mat Pro for sink units

Slate grey plastic, for preventing water damage in sink units not suitable for front pull-outs, only suitable for 561 mm side depth

### Upstands



WAP  
200/400/500 cm

Length 2000 mm

Length 4000 mm

Special length 5000 mm

#### Plastic upstand

Top section with sealing lips, dimensions: 25 mm high, 25 mm deep, **delivered as strand material.**

Available in all worktop décors, **also available in:**  
No. 014 Stainless steel appearance



WAP-Z

#### WAP accessory bag

matches the plastic upstands WAPN consisting of:

- 4 x interior corner 90°
- 2 x interior corner 135°
- 2 x exterior corner 90°
- 2 x set of end caps



WAPN  
200/400/500 cm

Length 2000 mm

Length 4000 mm

Special length 5000 mm

#### Upstands for continuous planning with niche cladding

2-piece plastic profile with sealing lip, incl. vertical sealing profile dimensions: 25 mm high, 25 mm deep **delivered as strand material.**

**Available in:**  
014 Stainless steel appearance, 010 Black

*Bottom profile adds 4 mm to the worktop.*



WAPN-Z

#### WAP accessory bag

matches the plastic upstands WAPN consisting of:

- 4 x interior corner 90° / 2 x interior corner 135°
- 2 x exterior corner 90°
- 2 x set of end caps for WAPN
- 2 x set of end caps for niche cladding

**Available in:**  
014 Stainless steel appearance, 010 Black

## Waste collecting systems

### Waste collecting systems (fitted on bottom shelf behind hinged door)



**Built-in waste collector „Solo“**  
plastic, slate grey, with full pull-out, capacity: 20 litres,  
Built-in dimensions: h x w x d = 396 x 245 x 427 mm  
To be fitted on site onto the bottom shelf.

*Can be built-in upwards of 300 mm door width.*

*Take sink syphon into account and plan space saving connector 021!*

AS9430



**Built-in waste collector „Tandem“ as a full pull-out**  
with 2 bins for ecological waste separation, with mechanical pull-out and lid lifting system,  
dimensions: h x w x d = 415 x 250 x 480 mm. Volume: 2 x 15 l.  
To be fitted on site onto the bottom shelf.

*Can be built-in upwards of 300 mm door width.*

*Take sink syphon into account and plan space saving connector 021!*

AS4311



**Built-in waste collector Bio-Trio 30 DT**  
With 3 plastic bins, Orion grey,  
for odourless, ecological waste separation,  
plastic parts Orion grey, capacity: 3 x 10 litres, incl. bio lid,  
h x w x d = 385 x 254 x 475 mm  
To be fitted on site onto the bottom shelf.

*Can be built-in upwards of 300 mm door width.*

*Take sink syphon into account and plan space saving connector 021!*

AS4753



**Built-in waste collector „space saving Tandem“**  
sorting in 3 bins:  
volume: 1 x 18 l, 2 x 8.5 l,  
1 additional bio lid,  
h x w x d = 320 x 336 x 471 mm

*Can be built-in upwards of 400 mm door width.*

*Take sink syphon into account and plan space saving connector 021!*

AS4742



**Built-in waste collector „space saving Tandem S“**  
sorting in 3 bins:  
volume: 1 x 12 l, 2 x 8.5 l,  
1 additional bio lid,  
h x w x d = 347 x 434 x 330 mm

*Can be built-in upwards of 500 mm door width.*

*Take sink syphon into account and plan space saving connector 021!*

AS9431



**Waste collector 40 DT**  
2 plastic bins, Orion grey,  
for ecological waste separation, capacity: 2 x 16 l,  
h x w x d = 320 x 338 x 475 mm  
To be fitted on site onto the bottom shelf.

*Can be built-in upwards of 400 mm door width.*

*Take sink syphon into account and plan space saving connector 021!*

AS4752

### Waste collecting systems (pull-outs, fitted to the front)



#### Built-in waste collector „Syncro“

Fully synchronised pull-out rails, with over extension runner, cushioned and covered, metal and plastic parts in slate grey.  
h x d: 424 x 400 mm  
Contents: 2 x 18 litres

Matching sink units: *SPUA(D)45(-X) / SPUA45(-M) / NSPUAL45(-X)!*

AS3550

AS3551

**as above**, however, with the following contents:  
1 x 18 l, 2 x 13 l, 1 additional bio lid

Matching sink units: *SPUA(D)50(-X) / SPUA50(-M) / NSPUAL50(-X)!*

AS3552

**as above**, however, with the following contents:  
2 x 28 l

Matching sink units: *SPUA(D)60(-X) / SPUA60(-M) / NSPUAL60(-X)!*

AS3553

**as above**, however, with the following contents:  
1 x 28 l, 2 x 13 l, 1 additional bio lid

Matching sink units: *SPUA(D)60(-X) / SPUA60(-M) / NSPUAL60(-X)!*



#### Built-in waste collector „X-Line“ X45 M35 Basic

35-litre large container with cover frame with flexible bin liner clamping system, suitable for 35-litre waste bags, Basic drawer as partial pull-out,  
h x w x d: 393 x 418 x 368 mm

Matching sink units: *SPUA(D)-BW45/SPUA(D)K-BW45(-X) and NSPUA(K)-BW45(-X)!*

AS9426

AS9428

#### Built-in waste collector “X-Line” X50 M35 Basic

**as above**, but  
h x w x d: 393 x 468 x 368 mm

Matching sink units: *SPUA(D)-BW50/SPUA(D)K-BW50(-X) and NSPUA(K)-BW50(-X)!*



#### Built-in waste collector “X-Line” X60 M7 Basic

**as above**, but with additional 15 litre container with lid,  
h x w x d: 393 x 568 x 368 mm

Matching sink units: *SPUA(D)-BW60/SPUA(D)K-BW60(-X) and NSPUA(K)-BW60(-X)!*

AS9429



#### Built-in waste collector “X-Line” X60 M5 Basic

**as above**, but with additional base tray that can be placed on the left or right  
8- and 5-litre container with lid,  
h x w x d: 393 x 568 x 368 mm

Matching sink units: *SPUA(D)-BW60/SPUA(D)K-BW60(-X) and NSPUA(K)-BW60(-X)!*

AS9433



## Waste collecting systems

### Waste collecting systems (fitted to hinged door)



AS9441

#### **Built-in waste collector, silver-coloured**

made of metal with removable plastic waste bins,  
lid and rims are black plastic, right-hand side or left-hand side mounting,  
no load on door hinges, 13 l capacity.  
Lid automatically lifts upon opening door. Dimensions: h x w x d = 470 x 340 x 285 mm  
**Please note:** Only mount waste collector on side wall with door hinge or on centre stile with corner sink units.

*Can be built-in upwards of 400 mm door width.*



AS9449

#### **Built-in waste collector**

flat design, 19 l volume container. Installation dimensions: h x w x d = 470 x 410 x 210 mm.  
**Please note!** Waste container only to be fitted to the side wall with door fittings,  
or to the centre post of corner sink units.  
In case of corner sink units, the adapter, order No. 9465 (to be fitted to the centre post) is required.

*Can be built-in upwards of 450 mm door width.*



AS9440

#### **Econtainer Junior, double waste collector**

flat design, with two 10 l and 19 l bins.  
Dimensions: h x w x d = 470 x 460 x 400 mm.  
**Please note!** Waste connector can only be fitted to the side panel with door fittings,  
or to the centre post of corner sink units.  
In case of corner sink units the adapter, order No. 9465 (to be fitted to the centre post) is required.

*Can be built-in upwards of 500 mm door width.*

Front bin fits underneath the sink connections, order space saving adapter 021.



AS9450

#### **Built-in waste collector „Euro Flexx“**

35 l large container with cover frame and bin liner clamping system,  
fits 1 x 35 l or 2 x 17 l,  
lid with indentation  
can be mounted on the right or left  
h x w x d = 499 x 370 x 356 mm

*Can be built-in upwards of 450 mm door width.*

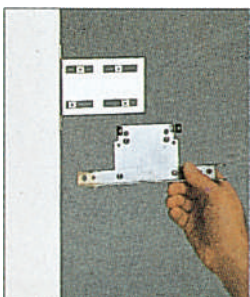

ASZ9465

#### **Adapter for corner sink base units with centre post, galvanised**

suitable for all Econtainers and 9449 / 9440 waste collectors.  
**Please note!** Observe door widths to be sufficient to allow the installation of waste collectors.  
Screw the adapter to the centre post, and then fasten the waste collector holder.

Height grid, carcase heights

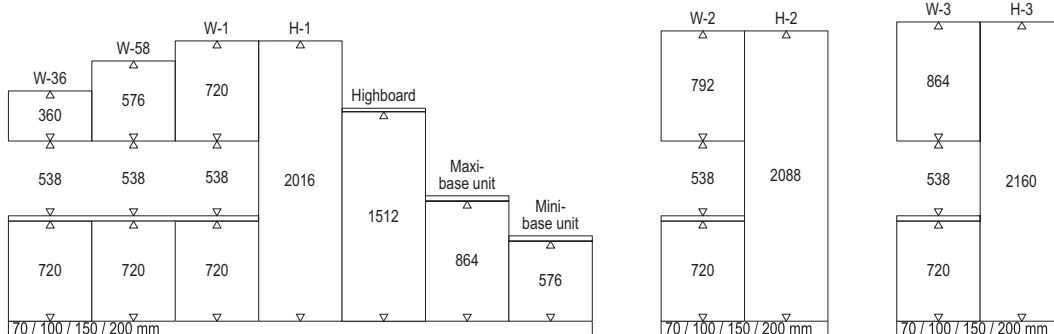

Height grid, XL carcase heights

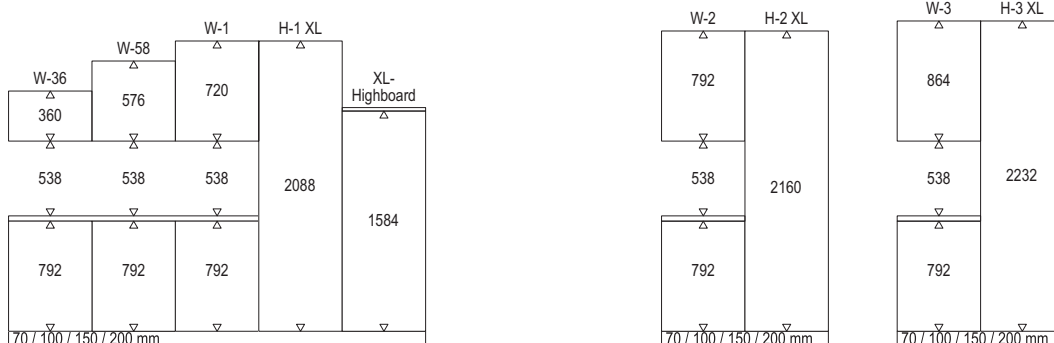

Height grid, standard and maxi door dimensions

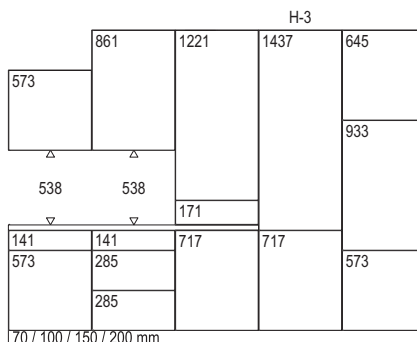
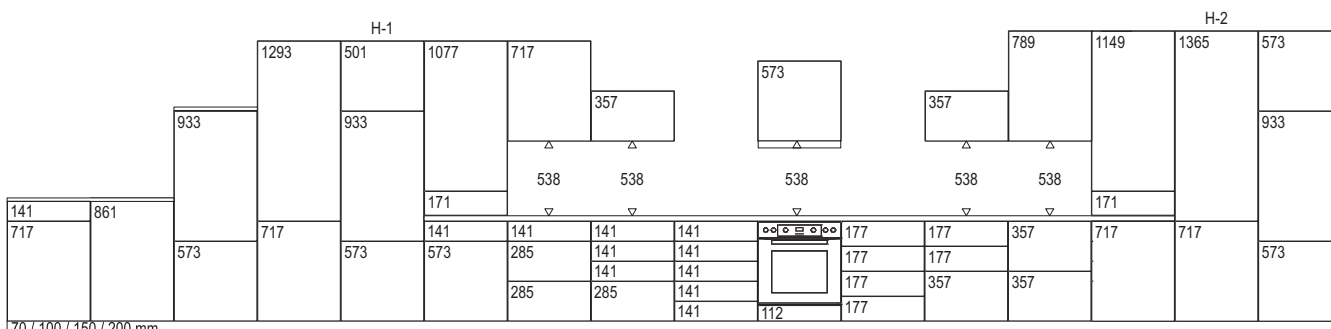

Height grid, XL door dimensions, Height 1

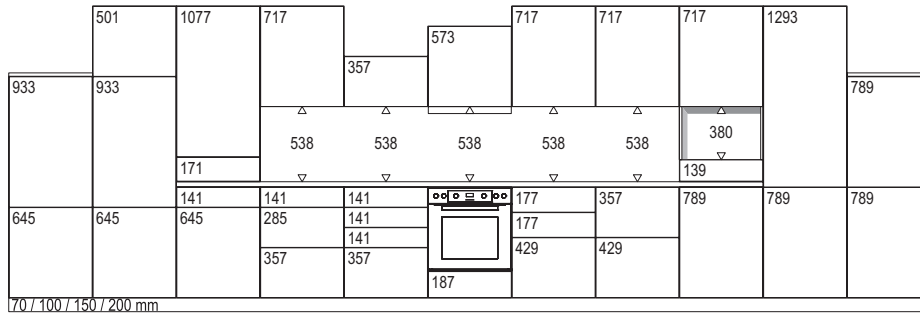

Height grid, XL door dimensions, Height 2

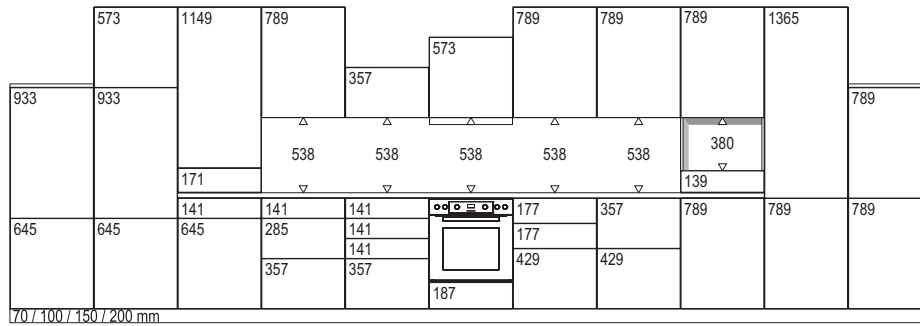

Height grid, XL door dimensions, Height 3

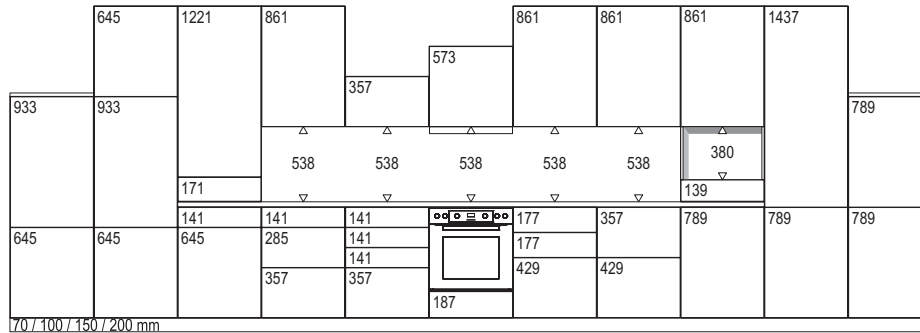

Height grid, tall units

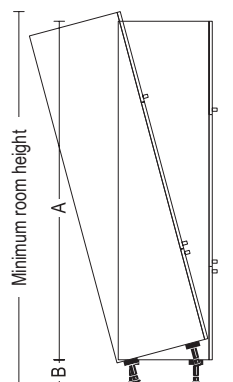

Minimum room heights

A* B*	70 mm	100 mm	150 mm	200 mm
2016 mm	2147 mm	2176 mm	2224 mm	2273 mm
2088 mm	2217 mm	2246 mm	2295 mm	2343 mm
2160 mm	2287 mm	2316 mm	2365 mm	2414 mm
2232 mm	2357 mm	2386 mm	2435 mm	2484 mm

A\* = Tall unit height  
B\* = Plinth height

